

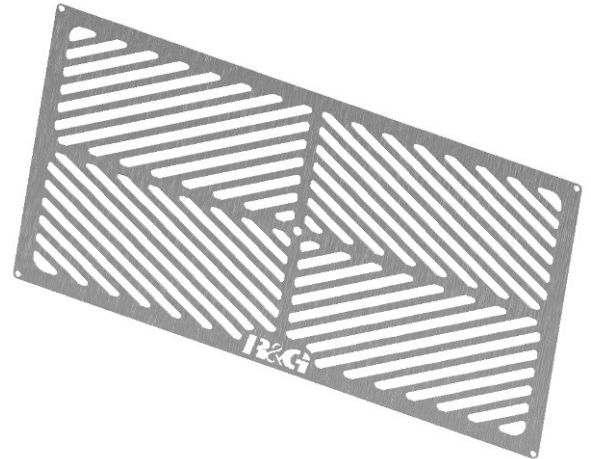

**FITTING INSTRUCTIONS FOR SRG0093 RADIATOR GUARD
FOR YAMAHA TRACER 7 2021-**



PICTURE A



PICTURE B

THIS KIT CONTAINS THE ITEMS PICTURED AND LABELLED OVER PAGE.

SOME PARTS MAY BE SHOWN FOR CLARITY OF INSTRUCTIONS ONLY.

DO NOT PROCEED UNTIL YOU ARE SURE ALL PARTS ARE PRESENT.

PLEASE READ ALL INSTRUCTIONS BEFORE PROCEEDING.

**IF IN ANY DOUBT WHEN FITTING OUR PRODUCTS, CONSULT ONE OF
OUR DEALERS OR HAVE FITTED BY A QUALIFIED TECHNICIAN.**

PLEASE NOTE THAT THE WAY THE KIT IS PACKED DOES NOT NECESSARILY REPRESENT THE
WAY OF MOUNTING TO THE BIKE.

IN THE EVENT OF RUBBER WASHERS BEING USED TO HOLD COMPONENTS ONTO BOLTS,
THESE RUBBER WASHERS CAN BE THROWN AWAY.

DIGITAL COPIES OF THESE INSTRUCTIONS ARE AVAILABLE FROM:

WWW.RG-RACING.COM



<u>TOOLS REQUIRED</u>	<u>GENERAL TORQUE SETTINGS</u>
<ul style="list-style-type: none"> Set of metric Allen keys. 	M4 BOLT = 8Nm M5 BOLT = 12Nm M6 BOLT = 15Nm M8 BOLT = 20Nm M10 BOLT = 40Nm M12 BOLT = 40Nm

LEGEND

ITEM NO.	DESCRIPTION	QTY
ITEM 1	STAINLESS RADIATOR GUARD (SS RAD0093SS)	1
ITEM 2	SELF ADHESIVE FOAM x 100mm LONG	4
ITEM 3	CABLE TIES (CT0220)	8



PICTURE 1

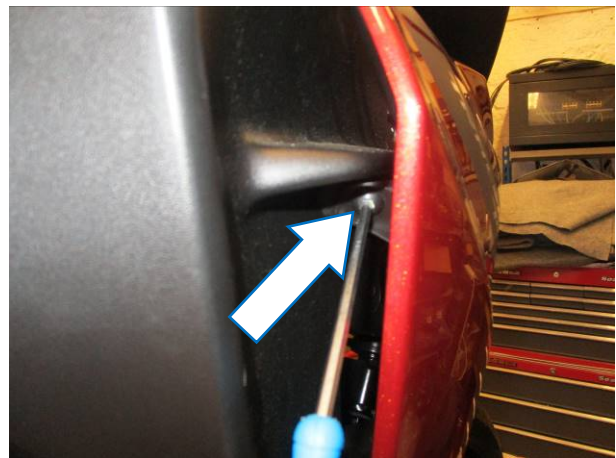

PICTURE 2



PICTURE 3



PICTURE 4



PICTURE 5

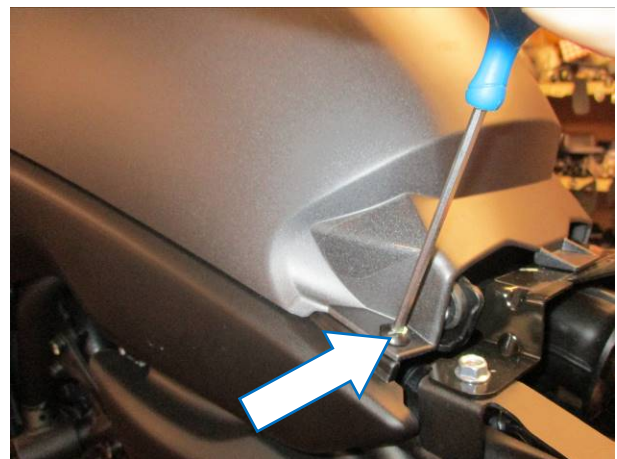

PICTURE 6



PICTURE 7

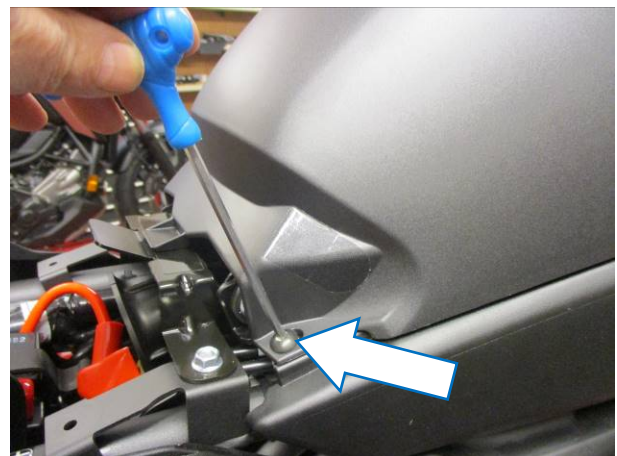

PICTURE 8

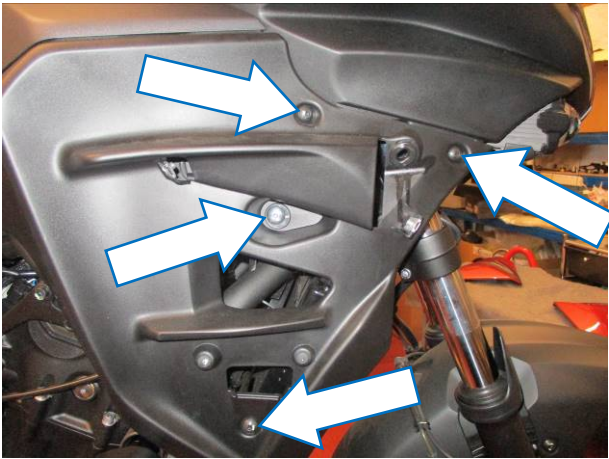

PICTURE 9

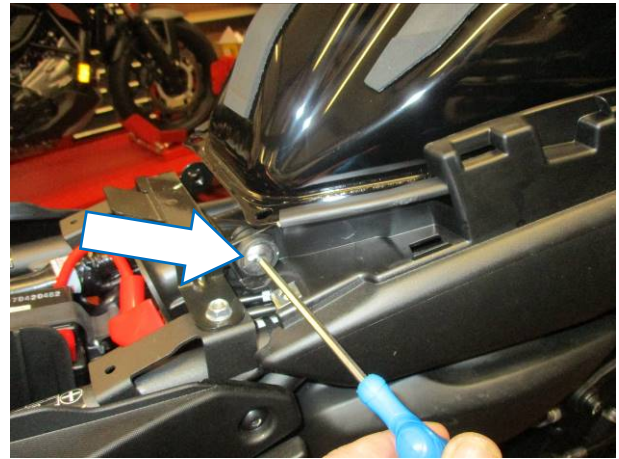

PICTURE 10



PICTURE 11



PICTURE 12



PICTURE 13



PICTURE 14

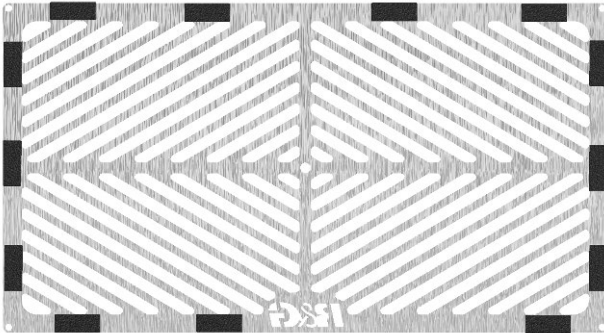

PICTURE 15

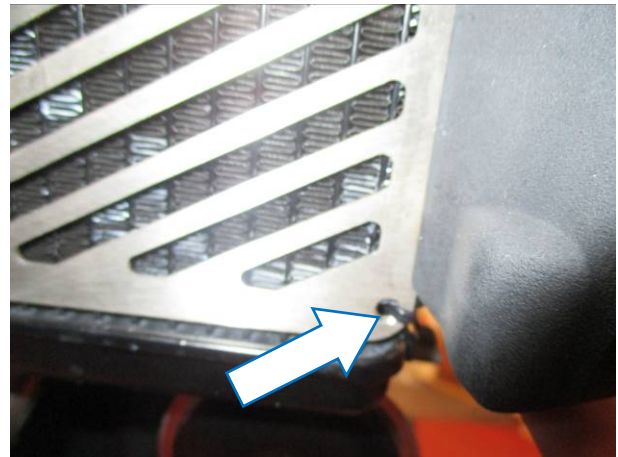

PICTURE 16

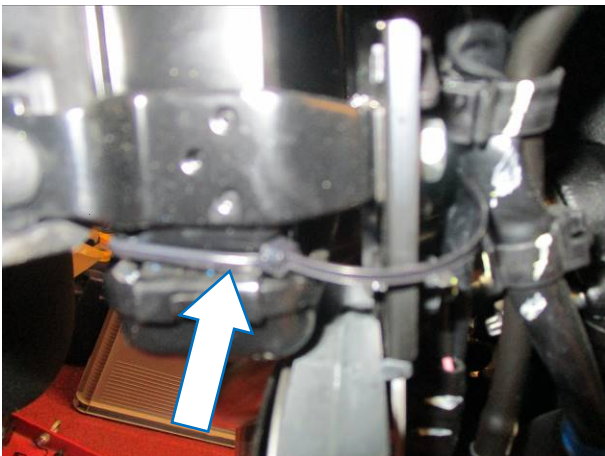

PICTURE 17



PICTURE 18

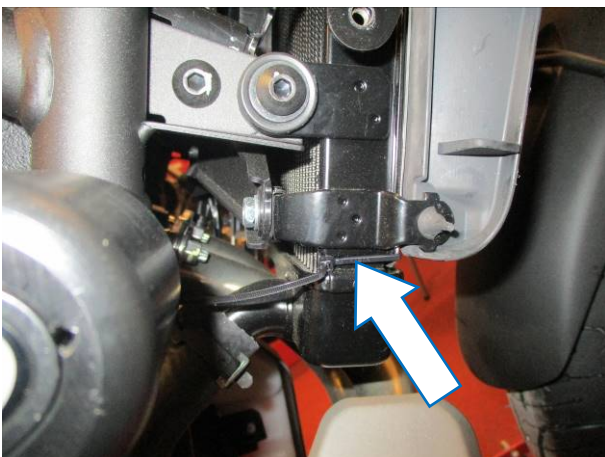

PICTURE 19



PICTURE 20



PICTURE 21



PICTURE 22

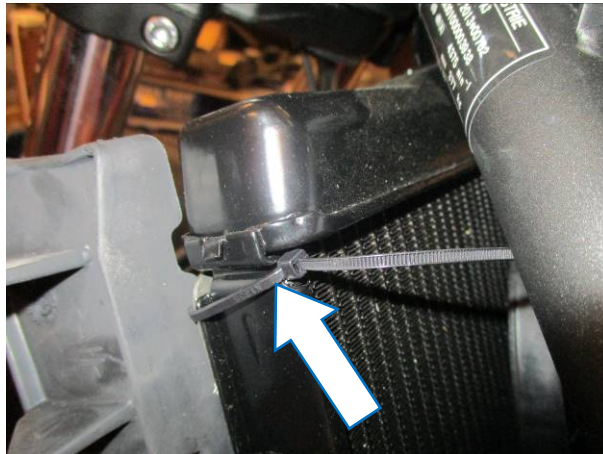

PICTURE 23

FITTING INSTRUCTIONS

- Remove the seat using key.
- Remove the two bolts arrowed in **pictures 1 and 2**, then remove the outer left-hand side fairing.
- Remove the two bolts arrowed in **pictures 3 and 4**, then remove the outer right-hand side fairing.
- Remove the four bolts arrowed in **pictures 5, 6, 7 and 8**, then remove the fuel tank cover.
- Remove the six bolts arrowed in **pictures 9, 10 and 11**, then remove the right-hand side inner panel.
- Remove the six bolts arrowed in **pictures 12, 13 and 14**, then remove the left-hand side inner panel.
- To fit the radiator guard to the bike, first cut the self-adhesive foam strip provided (**item 2**) into 10mm wide pieces and stick them to the back of the radiator guard frame (**item 1**), so that they will sit between the radiator guard and the radiator as shown in **picture 15**.
- Offer the radiator guard into position and use the supplied cable ties to secure the guard into position as shown in **pictures 16, 17, 18, 19, 20, 21, 22 and 23** ensuring to pass the cable ties through the radiator frame and not the cooling matrix. Once the cable ties are secure, trim off the excess

R&G

Unit 1, Shelley's Lane, East Worldham, Alton, Hampshire, GU34 3AQ

Tel: +44 (0)1420 89007 Fax: +44 (0)1420 87301 www.rg-racing.com Email: info@rg-racing.com



- Refit all panels and fairings as original.
ISSUE 1 04/08/2021 (NSY)

CONSUMER NOTICE

The catalogue description and any exhibition of samples are only broad indications of the Products and R&G may make design changes which do not diminish their performance or visual appeal and supplying them in such state shall conform to the order. The Buyer acknowledges no representation or warranty (other than as to title) has been given or will apply to the Products other than those in R&G's order or confirmation and the Buyer confirms it has chosen the Products as being of merchantable quality and suitable for its particular purposes. Where R&G fits the Products or undertakes other services it shall exercise reasonable skill and care and rectify any fault free of charge unless the workmanship has been disturbed. The Buyer is responsible for ensuring that the warranty on the motorcycle is not affected by the fitting of the Products. On return of any defective Products R&G shall at its option either supply a replacement or refund the purchase money but shall not be liable if the Products have been modified or used or maintained otherwise than in accordance with R&G's or manufacturer's instructions and good engineering practice or if the defect arises from accident or neglect. Other than identified above and subject to R&G not limiting its liability for causing death and personal injury, it shall not be liable for indirect or consequential loss and otherwise its liability shall be limited to the amounts paid by the Buyer for the Products or the fitting or service concerned. These terms do not affect the Buyer's statutory rights.

R&G RETURNS POLICY (NON-FAULTY GOODS)

Returns must be pre-authorized (if not pre-authorized the return will be rejected). Goods may only be returned direct to us if they were purchased direct from us (customer must prove if necessary). Otherwise to be returned to original vendor. Goods must be in re-sellable condition, in the opinion of R&G. All returns are subject to a 25% restocking and handling fee (25% of the gross value exc. P&P – at the prevailing price at time of purchase). The customer must pay any and all carriage charges. No returns of discontinued products, unless within 14 days of purchase. This policy does not affect your statutory rights and does not refer to faulty goods.

R&G



**NOTICE DE MONTAGE POUR SRG0093 GRILLE DE RADIATEUR
POUR YAMAHA TRACER 7 2021-**



PHOTO A

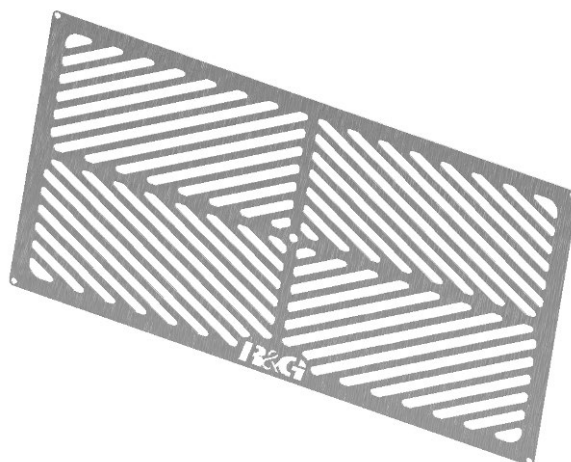

PHOTO B

CE KIT CONTIENT LES ARTICLES ILLUSTRÉS ET ÉTIQUETES SUR LA PAGE.

CERTAINES PARTIES PEUVENT ÊTRE PRÉSENTES UNIQUEMENT POUR LA CLARTE DES INSTRUCTIONS.

NE PAS PROCÉDER AU MONTAGE TANT QUE VOUS N'ÊTES PAS SÛR QUE TOUTES LES PIÈCES SOIENT PRÉSENTES.

VEUILLEZ LIRE TOUTES LES INSTRUCTIONS AVANT DE CONTINUER.

EN CAS DE DOUTE LORS DU MONTAGE DE NOS PRODUITS, CONSULTEZ UN DE NOS REVENDEURS OU FAITES APPEL À UN TECHNICIEN QUALIFIÉ.

VEUILLEZ NOTER QUE LA FAÇON DONT LE KIT EST EMBALLÉ NE REPRÉSENTE PAS NECESSAIREMENT LA MANIÈRE DE LE MONTER SUR LA MOTO.

SI DES RONDELLES EN CAOUTCHOUC SONT UTILISÉES POUR MAINTENIR LES COMPOSANTS SUR LES BOULONS, ELLES PEUVENT ÊTRE JETÉES.

NOTICE DISPONIBLE AU TÉLÉCHARGEMENT SUR :

WWW.RG-RACING.COM



<u>OUTILS REQUIS</u>	<u>VALEURS DE SERRAGE</u>
<ul style="list-style-type: none"> • Clés Allen. 	M4 BOULON = 8Nm M5 BOULON = 12Nm M6 BOULON = 15Nm M8 BOULON = 20Nm M10 BOULON = 40Nm M12 BOULON = 40Nm

LÉGENDE

ARTICLE NO.	DESCRIPTION	QTÉ
ARTICLE 1	GRILLE DE PROTECTION RADIATEUR (SS RAD0093SS)	1
ARTICLE 2	MOUSSE AUTOCOLLANTE x 100mm DE LONG	4
ARTICLE 3	COLLIERS DE SERRAGE (CT0220)	8



PHOTO 1



PHOTO 2

R&G



PHOTO 3



PHOTO 4



PHOTO 5

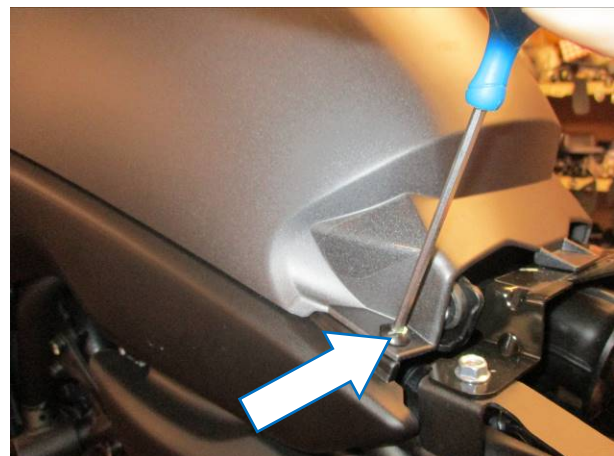

PHOTO 6



PHOTO 7

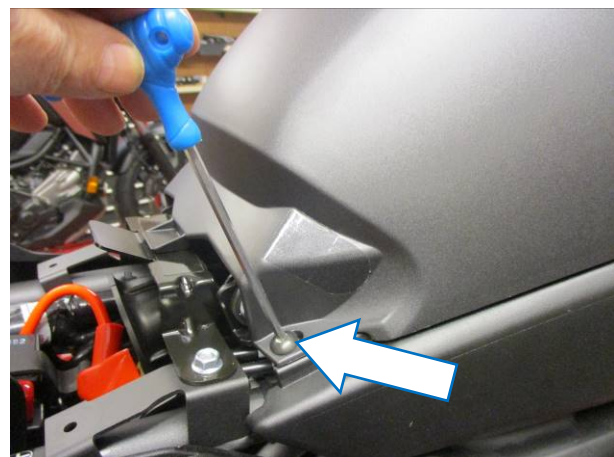

PHOTO 8



PHOTO 9

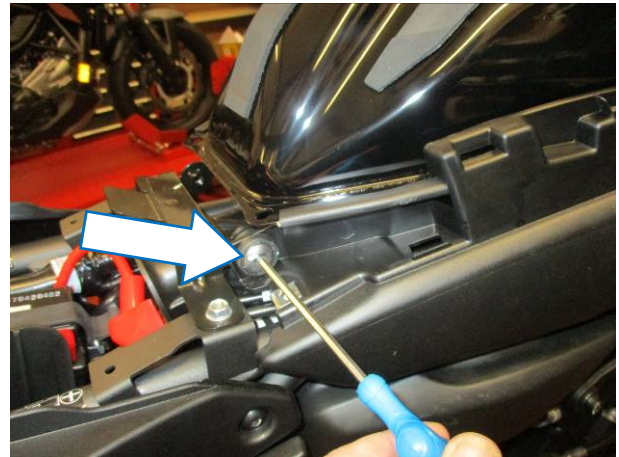

PHOTO 10



PHOTO 11



PHOTO 12



PHOTO 13



PHOTO 14

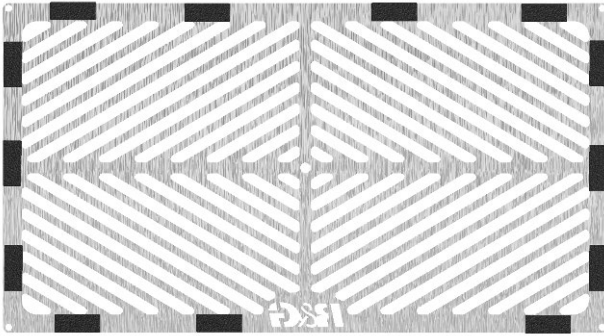

PHOTO 15

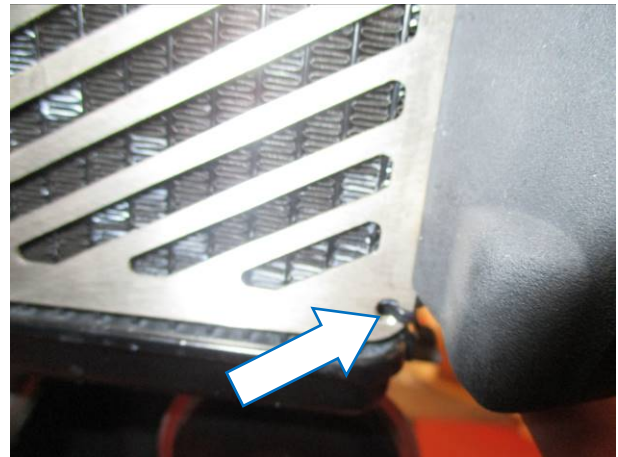

PHOTO 16

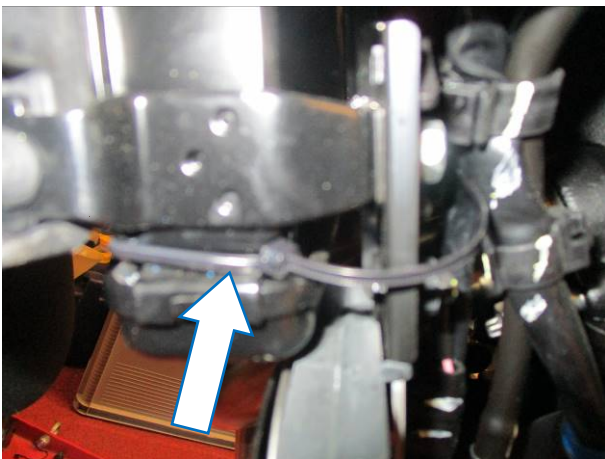

PHOTO 17



PHOTO 18

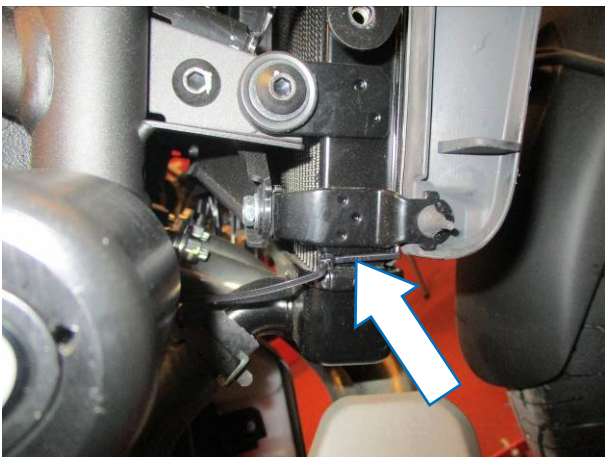

PHOTO 19

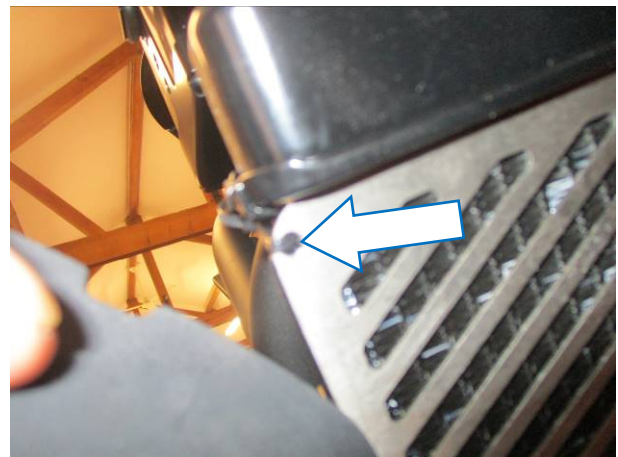

PHOTO 20

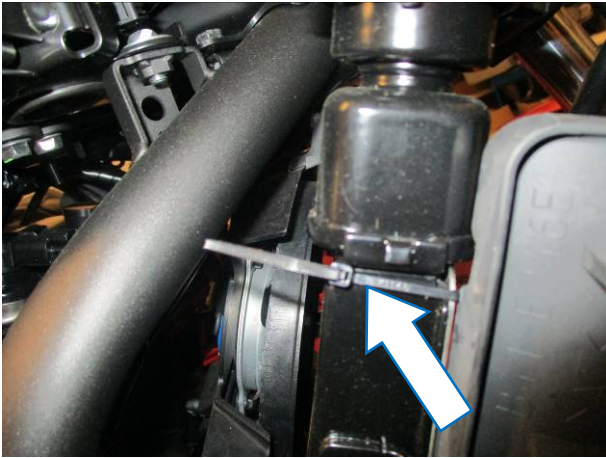

PHOTO 21

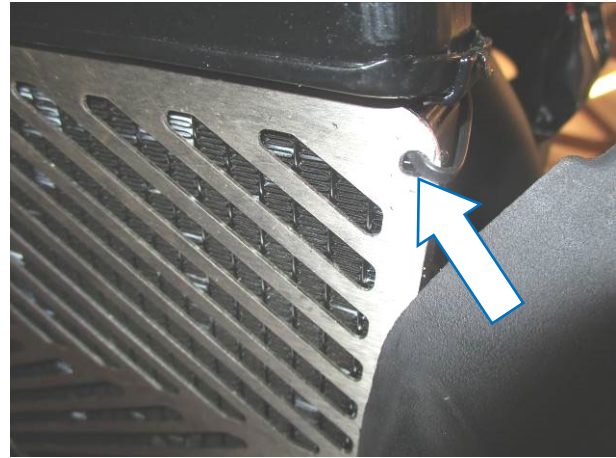

PHOTO 22

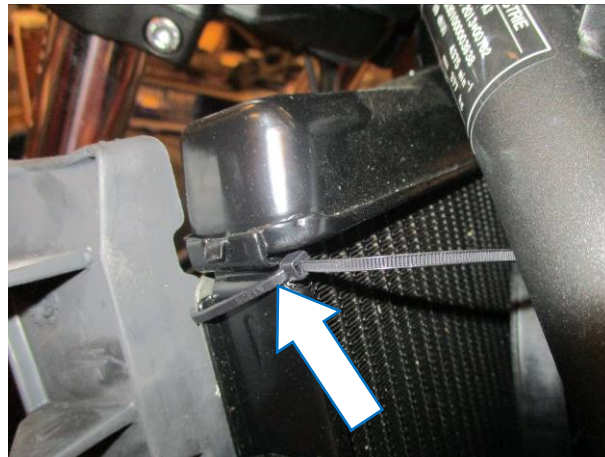

PHOTO 23

NOTICE DE MONTAGE

- Retirer le siège à l'aide de la clé.
- Déposer les deux vis fléchées sur les photos 1 et 2, puis déposer le carénage extérieur gauche.
- Déposer les deux vis fléchées sur les photos 3 et 4, puis déposer le carénage extérieur droit.
- Retirez les quatre boulons fléchés sur les photos 5, 6, 7 et 8, puis retirez le couvercle du réservoir de carburant.
- Retirez les six boulons fléchés sur les photos 9, 10 et 11, puis retirez le panneau intérieur droit.
- Retirez les six boulons fléchés sur les photos 12, 13 et 14, puis retirez le panneau intérieur latéral gauche.
- Pour monter la protection de radiateur sur la moto, découpez d'abord la bande de mousse autocollante fournie (article 2) en morceaux de 10 mm de large et collez-les à l'arrière du cadre de protection de radiateur (article 1), de manière à ce qu'elles se placent entre le protège-radiateur et le radiateur comme indiqué sur la photo 15.
- Mettez la protection du radiateur en place et utilisez les colliers de serrage fournis pour fixer la protection en position comme indiqué sur les photos 16, 17, 18, 19,

R&G

Unit 1, Shelley's Lane, East Worldham, Alton, Hampshire, GU34 3AQ

Tel: +44 (0)1420 89007 Fax: +44 (0)1420 87301 www.rg-racing.com Email: info@rg-racing.com



20, 21, 22 et 23 en veillant à faire passer les colliers à travers le cadre du radiateur et non la matrice de refroidissement. Une fois les colliers fixés, coupez l'excédent.

- Remonter tous les panneaux et carénages comme d'origine.

ISSUE 1 04/08/2021 (NSY)

CONSUMER NOTICE

The catalogue description and any exhibition of samples are only broad indications of the Products and R&G may make design changes which do not diminish their performance or visual appeal and supplying them in such state shall conform to the order. The Buyer acknowledges no representation or warranty (other than as to title) has been given or will apply to the Products other than those in R&G's order or confirmation and the Buyer confirms it has chosen the Products as being of merchantable quality and suitable for its particular purposes. Where R&G fits the Products or undertakes other services it shall exercise reasonable skill and care and rectify any fault free of charge unless the workmanship has been disturbed. The Buyer is responsible for ensuring that the warranty on the motorcycle is not affected by the fitting of the Products. On return of any defective Products R&G shall at its option either supply a replacement or refund the purchase money but shall not be liable if the Products have been modified or used or maintained otherwise than in accordance with R&G's or manufacturer's instructions and good engineering practice or if the defect arises from accident or neglect. Other than identified above and subject to R&G not limiting its liability for causing death and personal injury, it shall not be liable for indirect or consequential loss and otherwise its liability shall be limited to the amounts paid by the Buyer for the Products or the fitting or service concerned. These terms do not affect the Buyer's statutory rights.

R&G RETURNS POLICY (NON-FAULTY GOODS)

Returns must be pre-authorized (if not pre-authorized the return will be rejected). Goods may only be returned direct to us if they were purchased direct from us (customer must prove if necessary). Otherwise to be returned to original vendor. Goods must be in re-sellable condition, in the opinion of R&G. All returns are subject to a 25% restocking and handling fee (25% of the gross value exc. P&P – at the prevailing price at time of purchase). The customer must pay any and all carriage charges. No returns of discontinued products, unless within 14 days of purchase. This policy does not affect your statutory rights and does not refer to faulty goods.

R&G

Unit 1, Shelley's Lane, East Worldham, Alton, Hampshire, GU34 3AQ

Tel: +44 (0)1420 89007 Fax: +44 (0)1420 87301 www.rg-racing.com Email: info@rg-racing.com



**MONTAGEANLEITUNG FÜR SRG0093 KÜHLERSCHUTZ
FÜR YAMAHA TRACER 7 2021-**



ABBILDUNG A



ABBILDUNG B

**ALLE KIT-TEILE SIND AUF DEN NACHFOLGENDEN SEITEN ABGEBILDET UND
GEKENNZEICHNET.**

DIE ABGEBILDETEN TEILE DIENEN LEDIGLICH ZUR ERKLÄRUNG.

ÜBERPRÜFEN SIE ZUERST, DASS ALLE TEILE VORHANDEN SIND.

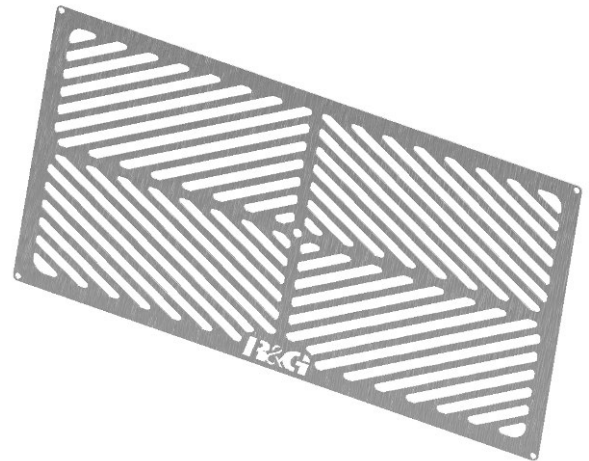
LESEN SIE DIE MONTAGEANLEITUNG KOMPLETT DURCH, BEVOR SIE ANFANGEN.

**WENN SIE BEI DER MONTAGE DIESES PRODUKTES UNSICHER SIND,
BITTE EINEN UNSERER HÄNDLER KONTAKTIEREN ODER DAS KIT VON
EINEM QUALIFIZIERTEN ZWEIRAD-MECHANIKER MONTIEREN LASSEN.**

DIE VERPACKUNG DER TEILE STELLT NICHT DIE REIHENFOLGE DER MONTAGE DAR.

HINWEIS FÜR KITS MIT PLASTIKUNTERLEGSscheIBEN AN DEN SCHRAUBEN –
DIESE PLASTIK-UNTERLEGSscheIBEN WERDEN NICHT FÜR DEN EINBAU BENÖTIGT.

**EINE DIGITALE VERSION DIESER MONTAGEANLEITUNG KANN AUF
FOLGENDER SEITE HERUNTERGELADEN WERDEN:**

WWW.RG-RACING.COM

R&G

Unit 1, Shelley's Lane, East Worldham, Alton, Hampshire, GU34 3AQ
Tel: +44 (0)1420 89007 Fax: +44 (0)1420 87301 www.rg-racing.com Email: info@rg-racing.com



<u>SIE BENÖTIGEN FOLGENDES WERKZEUG</u>	<u>ALLGEM. ANZUGSDREHMOMENT</u>
<ul style="list-style-type: none"> Satz Inbusschlüssel 	M4 SCHRAUBE = 8Nm M5 SCHRAUBE = 12Nm M6 SCHRAUBE = 15Nm M8 SCHRAUBE = 20Nm M10 SCHRAUBE = 40Nm M12 SCHRAUBE = 40Nm

LIEFERUMFANG

ARTIKEL NR.	BESCHREIBUNG	MENGE
ARTIKEL 1	EDELSTAHL KÜHLERSCHUTZ (SS RAD0093SS)	1
ARTIKEL 2	SELBSTKLEBENDER SCHAUMSTOFF x 100mm	4
ARTIKEL 3	KABELBINDER (CT0220)	8



ABBILDUNG 1



ABBILDUNG 2



ABBILDUNG 3



ABBILDUNG 4



ABBILDUNG 5



ABBILDUNG 6

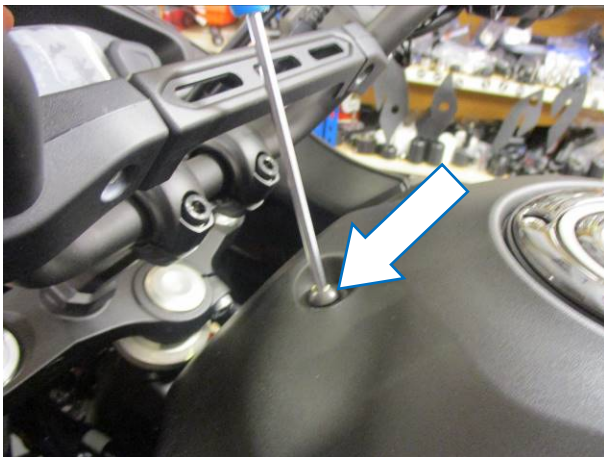

ABBILDUNG 7

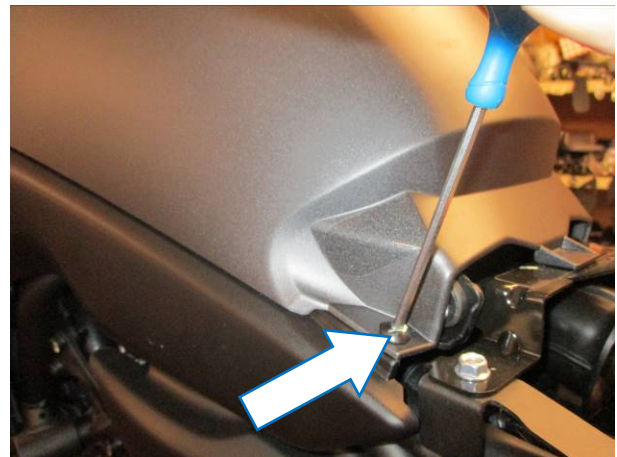

ABBILDUNG 8



ABBILDUNG 9

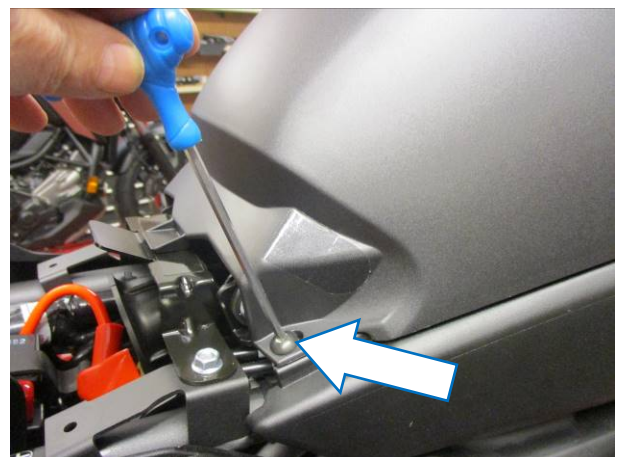

ABBILDUNG 10



ABBILDUNG 11

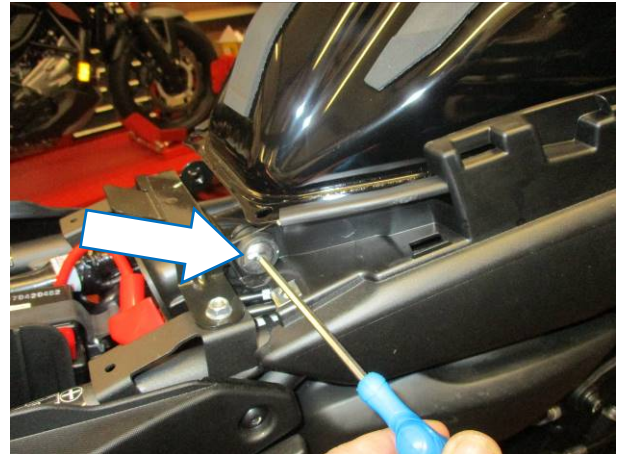

ABBILDUNG 12



R&G



ABBILDUNG 13

ABBILDUNG 14



ABBILDUNG 15

ABBILDUNG 16

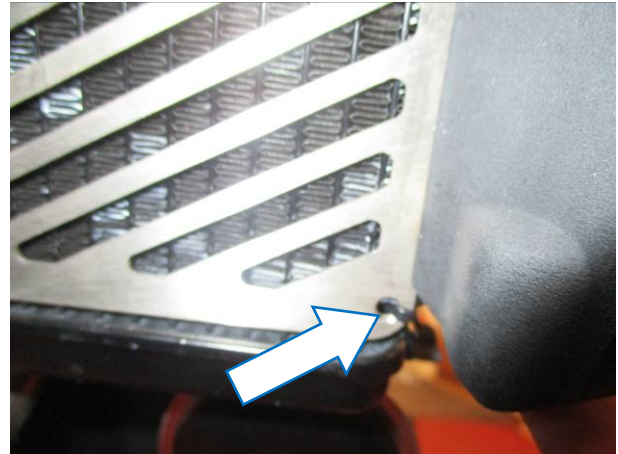
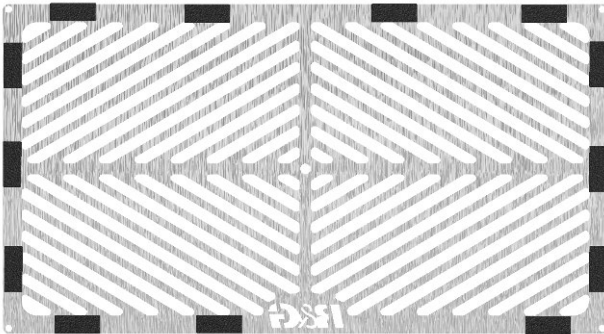

ABBILDUNG 17

ABBILDUNG 18



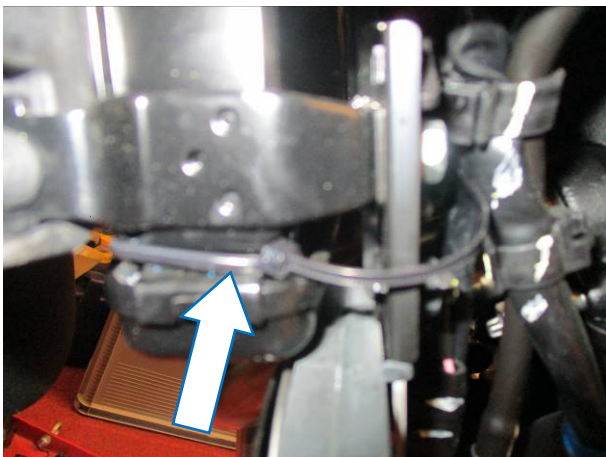

ABBILDUNG 21



ABBILDUNG 22

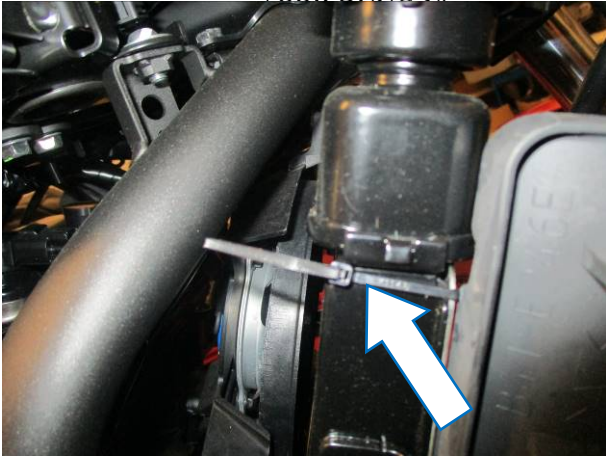

ABBILDUNG 23

MONTAGEANLEITUNG

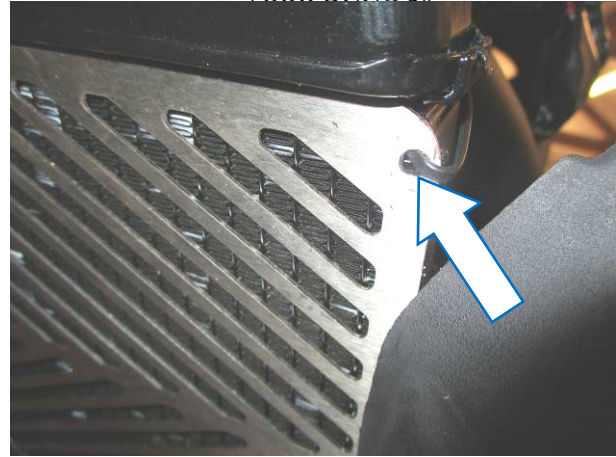
- Entfernen Sie den Sitz (hierzu benötigen Sie den Schlüssel).
- Entfernen Sie die zwei Schrauben, die in den **Abbildungen 1 und 2** gekennzeichnet sind, dann entfernen Sie die äußere linke Seitenverkleidung.
- Entfernen Sie die zwei Schrauben, die in den **Abbildungen 3 und 4** gekennzeichnet sind, dann entfernen Sie die äußere rechte Seitenverkleidung.
- Entfernen Sie die vier Schrauben, die in den **Abbildungen 5, 6, 7 und 8** gekennzeichnet sind, dann entfernen Sie die Abdeckung für den Kraftstofftank.
- Entfernen Sie die sechs Schrauben, die in den **Abbildungen 9, 10 und 11** gekennzeichnet sind, dann entfernen Sie das innere Verkleidungsteil an der rechten Seite.
- Entfernen Sie die sechs Schrauben, die in den **Abbildungen 12, 13 und 14** gekennzeichnet sind, dann entfernen Sie das innere Verkleidungsteil an der linken Seite.
- Um den Kühlerschutz am Motorrad montieren zu können, schneiden Sie die mitgelieferten Schaumstoffstreifen (**Artikel 2**) in 10 mm breite Streifen und kleben Sie diese auf der Rückseite des Kühlerschutzrahmens (**Artikel 1**), so dass sie zwischen dem Kühlerschutz und dem Kühler angebracht sind wie in **Abbildung 15** abgebildet.

R&G

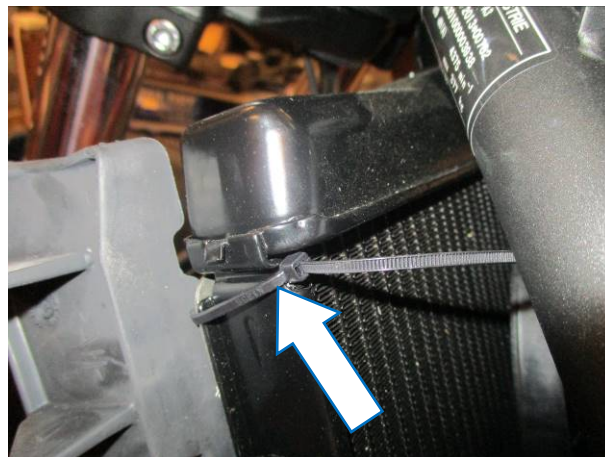
Unit 1, Shelley's Lane, East Worldham, Alton, Hampshire, GU34 3AQ

Tel: +44 (0)1420 89007 Fax: +44 (0)1420 87301 www.rg-racing.com Email: info@rg-racing.com



- Den Kühlerschutz in Position bringen und benutzen Sie die Kabelbinder vom Kit, um den Kühlerschutz in Position zu befestigen wie in den **Abbildungen 16, 17, 18, 19, 20, 21, 22 und 23** abgebildet. Stellen Sie sicher, dass die Kabelbinder durch den Kühlerrahmen gefädelt werden, nicht durch das Gitter des Kühlerschutz. Wenn die Kabelbinder sicher befestigt sind, das überschüssige Kabel abschneiden.
- Montieren Sie alle Verkleidungsteile und Seitenverkleidungen wie ursprünglich wieder.

AUSGABE 1 04/08/2021 (NSY)

CONSUMER NOTICE

The catalogue description and any exhibition of samples are only broad indications of the Products and R&G may make design changes which do not diminish their performance or visual appeal and supplying them in such state shall conform to the order. The Buyer acknowledges no representation or warranty (other than as to title) has been given or will apply to the Products other than those in R&G's order or confirmation and the Buyer confirms it has chosen the Products as being of merchantable quality and suitable for its particular purposes. Where R&G fits the Products or undertakes other services it shall exercise reasonable skill and care and rectify any fault free of charge unless the workmanship has been disturbed. The Buyer is responsible for ensuring that the warranty on the motorcycle is not affected by the fitting of the Products. On return of any defective Products R&G shall at its option either supply a replacement or refund the purchase money but shall not be liable if the Products have been modified or used or maintained otherwise than in accordance with R&G's or manufacturer's instructions and good engineering practice or if the defect arises from accident or neglect. Other than identified above and subject to R&G not limiting its liability for causing death and personal injury, it shall not be liable for indirect or consequential loss and otherwise its liability shall be limited to the amounts paid by the Buyer for the Products or the fitting or service concerned. These terms do not affect the Buyer's statutory rights.

R&G RETURNS POLICY (NON-FAULTY GOODS)

Returns must be pre-authorized (if not pre-authorized the return will be rejected). Goods may only be returned direct to us if they were purchased direct from us (customer must prove if necessary). Otherwise to be returned to original vendor. Goods must be in re-sellable condition, in the opinion of R&G. All returns are subject to a 25% restocking and handling fee (25% of the gross value exc. P&P – at the prevailing price at time of purchase). The customer must pay any and all carriage charges. No returns of discontinued products, unless within 14 days of purchase. This policy does not affect your statutory rights and does not refer to faulty goods.

R&G

Unit 1, Shelley's Lane, East Worldham, Alton, Hampshire, GU34 3AQ
Tel: +44 (0)1420 89007 Fax: +44 (0)1420 87301 www.rg-racing.com Email: info@rg-racing.com