



LP0177

FITTING INSTRUCTIONS FOR LP0177BK LICENCE PLATE BRACKET
DUCATI SCRAMBLER 2015-

Page | 1



THIS KIT CONTAINS THE ITEMS PICTURED AND LABELLED BELOW.
DO NOT PROCEED UNTIL YOU ARE SURE ALL PARTS ARE PRESENT.
Please note that the way the kit is packed does not necessarily represent the way of mounting to the bike

THE PARTS SHOWN MAY BE REPRESENTATIVE ONLY (FOR CLARITY OF INSTRUCTIONS ONLY)

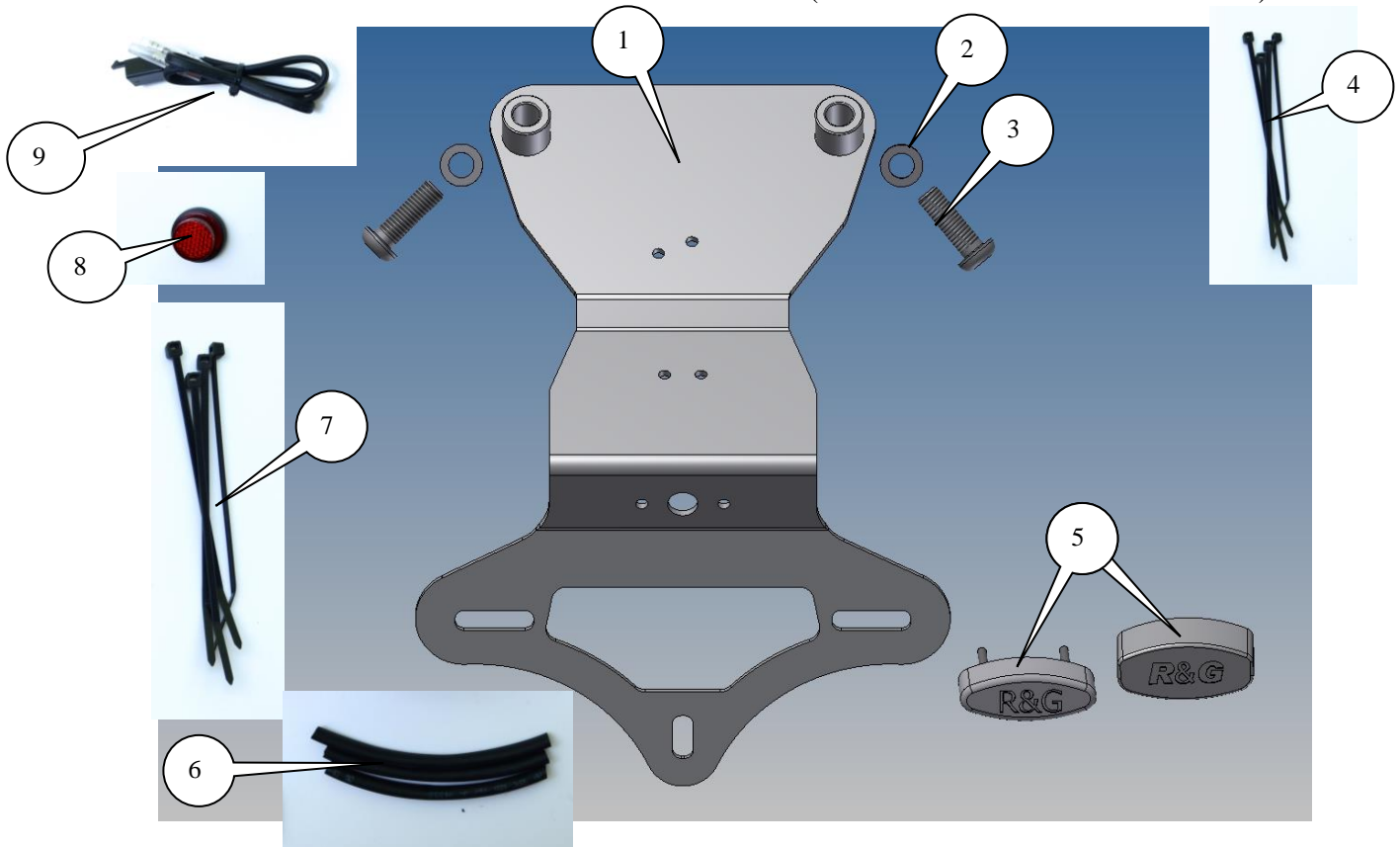



LP0177

LEGEND

ITEM 1 = LICENCE PLATE MOUNTING BRACKET (TB0177BK) (x1).

ITEM 2 = M8 WASHERS (x2).

ITEM 3 = M8x25mm BUTTON HEAD BOLTS (x2).

ITEM 4 = SMALL CABLE TIES (x4).

ITEM 5 = LICENCE PLATE ILLUMINATOR ASSEMBLY (LA0002) (x1).

ITEM 6 = 180mm LENGTHS OF HEAT SHRINK (x1).

ITEM 7 = LARGE CABLE TIES (x3).

ITEM 8 = REFLECTOR (REFL 1) (x1).

ITEM 9 = LICENCE PLATE ILLUMINATOR CONNECTOR (CON0014) (x1).

ITEM 10 = SELF ADHESIVE CABLE CLIPS (x2) (NOT SHOWN).

ITEM 11 = 100mm LENGTH SELF-ADHESIVE NEOPRENE FOAM (x1).

Page | 2

Please note that in cases where kits are packed with rubber washers holding the components onto the bolt – *the rubber washers should be thrown away!*

TOOLS REQUIRED

- Set of metric Allen keys to include 3, 4 and 5mm A/F.
- Set of Torx key to include T10 and T20.
- Small amount of super glue.

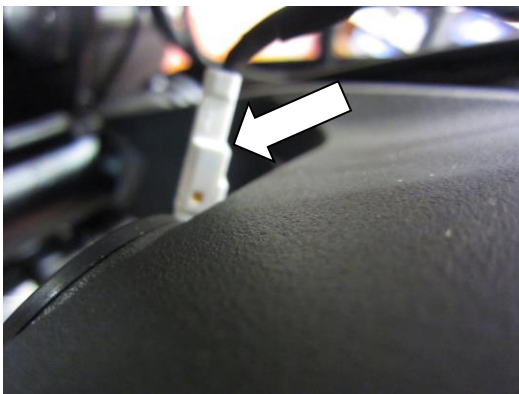

PICTURE 1

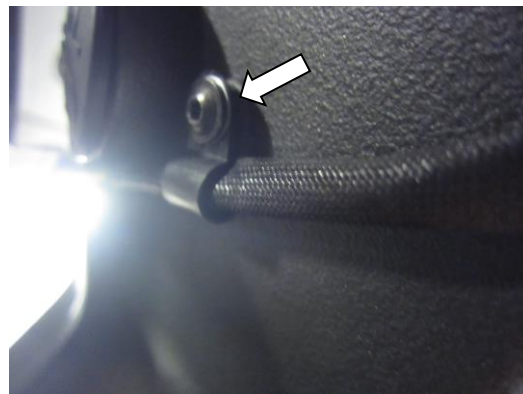

PICTURE 2

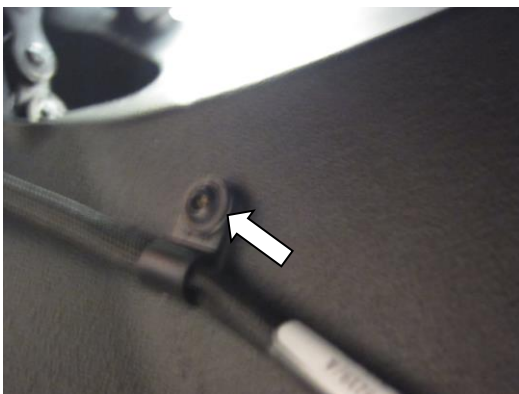

PICTURE 3



PICTURE 4



LP0177

Page | 3



PICTURE 5



PICTURE 6



PICTURE 7

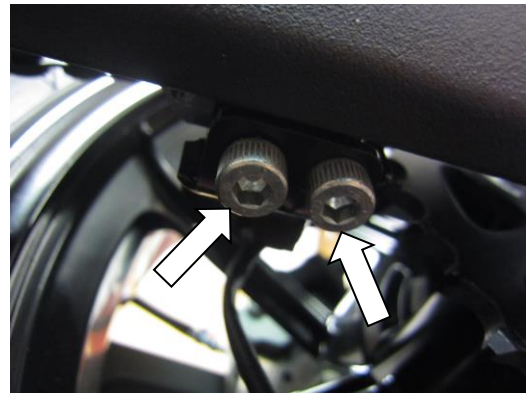

PICTURE 8



PICTURE 9



PICTURE 10



LP0177

Page | 4



PICTURE 11



PICTURE 12

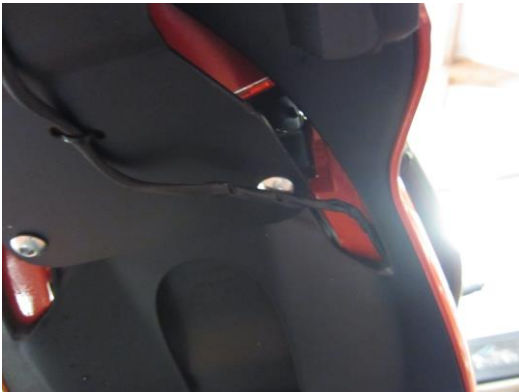

PICTURE 13



PICTURE 14



PICTURE 15



PICTURE 16



LP0177

Page | 5

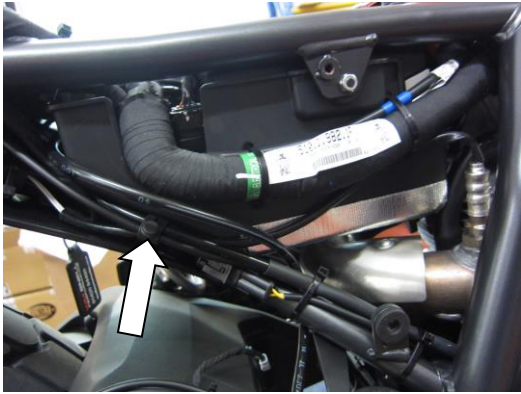

PICTURE 17

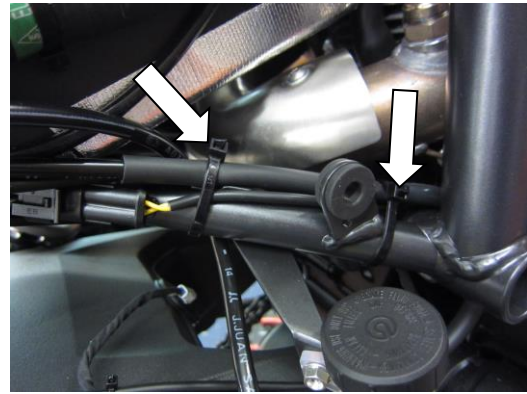

PICTURE 18



PICTURE 19

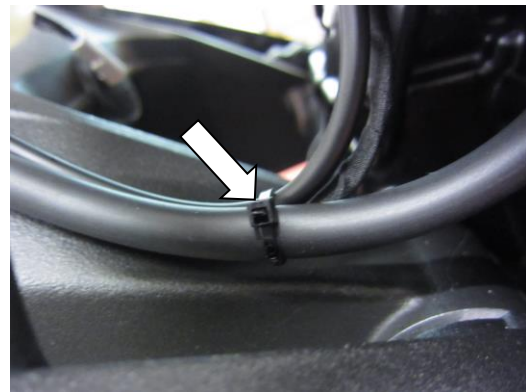

PICTURE 20



PICTURE 21



PICTURE 22



LP0177

Page | 6



PICTURE 23



PICTURE 24

FITTING INSTRUCTIONS

- Remove the seat using the key.
- Disconnect the licence plate illuminator wiring plug sockets arrowed in picture 1.
- Trace the wiring to the original licence plate illuminator and remove all the cable clamps as indicated in pictures 2 and 3.
- Remove the two bolts arrowed in pictures 4 and 5 and remove the chain guard (this is for access only and will be replaced).
- Remove the four bolts arrowed in pictures 6, 7 and 8 and carefully remove the original licence plate bracket. **Please note:- you do not have to remove the entire bracket if you wish to retain it and use as a rear fender/splash guard in which case you only have to remove the licence plate holder and illuminator.**
- Fit the new licence plate illuminator (item 5) to the licence plate mounting bracket (item 1) as shown in picture 10 (please use the provided heat shrink (item 6) to protect the wiring).
- **PLEASE NOTE YOU WILL NEED TO GLUE THE LIGHT SHROUD TO THE LED LICENCE PLATE ILLUMINATOR USING SUPER GLUE.**
- Use the self-adhesive clips (item 10) and two of the small cable ties (item 4) to tidy and secure the wiring as shown in picture 11.
- Trim and trim the self-adhesive foam to the top surface of the new licence plate bracket as shown in picture 12.
- Offer the new assembly into position as shown in picture 13 and secure using the M8 bolts (item 3) and washers (item 2).
- Remove the four bolts arrowed in pictures 14, 15 and 16, and remove the side panel to access the wiring.
- Remove all the cable ties and wiring tidies arrowed in pictures 17, 18, 19 and 20.
- Feed the new licence plate illuminator through the under tray/side cowl as shown in pictures 21 and 22.
- Connect the new licence plate illuminator to the original plug socket using the supplied connector (item 9) as shown in pictures 23 and 24. It is a good idea to switch on at this stage, if it fails to illuminate swop the wires over and recheck for operation.
- Use the remaining cable ties to neaten and tidy the wiring
- Refit the side panel.
- Refit the chain guard if required.
- Fit a licence plate to new licence plate bracket. **PLEASE NOTE YOU CAN NOT USE A FULL SIZE LICENCE PLATE WITH THIS PRODUCT.**

R&G Racing

Unit 1, Shelley's Lane, East Worldham, Alton, Hampshire, GU34 3AQ

Tel: +44 (0)1420 89007 Fax: +44 (0)1420 87301 www.rg-racing.com Email: info@rg-racing.com



LP0177

Page | 7

- **IMPORTANT: WHEN FITTING A LICENCE PLATE (NO MORE THAN 130mm TALL) IT MUST BE PLACED AS HIGH AS POSSIBLE ON THE LICENCE PLATE HANGER AND CHECKED FOR COLLISION WITH THE REAR WHEEL WHEN THE SUSPENSION IS AT FULL COMPRESSION, THERE IS A SMALL CHANCE OF THE LICENCE PLATE HITTING THE BACK WHEEL UNDER HEAVY LOAD AND OVER LARGE BUMPS IN THE ROAD. IT IS YOUR RESPONSIBILITY TO CHECK FOR THIS POSSIBILITY AND TAKE AVOIDING ACTION. FAILURE TO CHECK THIS COULD RESULT IN SERIOUS INJURY.**
- Refit the seat.
- Depending on local laws, attach enclosed red reflector (item 8) in an appropriate location.
- **Please test the indicators, rear light and licence plate illuminator before riding.**

Digital copies of these instructions are available to download from www.rg-racing.com

GENERAL TORQUE SETTINGS

M4 BOLT = 8Nm
M5 BOLT = 12Nm
M6 BOLT = 15Nm
M8 BOLT = 20Nm
M10 BOLT = 40Nm

ISSUE 1 08/10/2014 (NSY)

CONSUMER NOTICE

The catalogue description and any exhibition of samples are only broad indications of the Products and R&G may make design changes which do not diminish their performance or visual appeal and supplying them in such state shall conform to the order. The Buyer acknowledges no representation or warranty (other than as to title) has been given or will apply to the Products other than those in R&G's order or confirmation and the Buyer confirms it has chosen the Products as being of merchantable quality and suitable for its particular purposes. Where R&G fits the Products or undertakes other services it shall exercise reasonable skill and care and rectify any fault free of charge unless the workmanship has been disturbed. The Buyer is responsible for ensuring that the warranty on the motorcycle is not affected by the fitting of the Products. On return of any defective Products R&G shall at its option either supply a replacement or refund the purchase money but shall not be liable if the Products have been modified or used or maintained otherwise than in accordance with R&G's or manufacturer's instructions and good engineering practice or if the defect arises from accident or neglect. Other than identified above and subject to R&G not limiting its liability for causing death and personal injury, it shall not be liable for indirect or consequential loss and otherwise its liability shall be limited to the amounts paid by the Buyer for the Products or the fitting or service concerned. These terms do not affect the Buyer's statutory rights.

R&G RACING RETURNS POLICY (NON-FAULTY GOODS)

Returns must be pre-authorized (if not pre-authorized the return will be rejected). Goods may only be returned direct to us if they were purchased direct from us (customer must prove if necessary). Otherwise to be returned to original vendor. Goods must be in re-sellable condition, in the opinion of R&G Racing. All returns are subject to a 25% restocking and handling fee (25% of the gross value exc. P&P – at the prevailing price at time of purchase). The customer must pay any and all carriage charges. No returns of discontinued products, unless within 14 days of purchase. This policy does not affect your statutory rights and does not refer to faulty goods.

R&G Racing

Unit 1, Shelley's Lane, East Worldham, Alton, Hampshire, GU34 3AQ
Tel: +44 (0)1420 89007 Fax: +44 (0)1420 87301 www.rg-racing.com Email: info@rg-racing.com



LP0177

**INSTRUCTIONS DE MONTAGE POUR LP0177BK SUPPORT DE PLAQUE
DUCATI SCRAMBLER 2015-**

Page | 8



Le kit contient les articles exposés ci-dessous, vérifier que toutes les pièces soient présentes avant de procéder au montage.

La façon dont le kit est emballé ne correspond pas forcément à la façon de monter les pièces sur la moto.

**LES PARTIES PRESENTEES PEUVENT ETRE UNIQUEMENT REPRESENTATIVES
(POUR LA CLARTE DES INSTRUCTIONS UNIQUEMENT).**

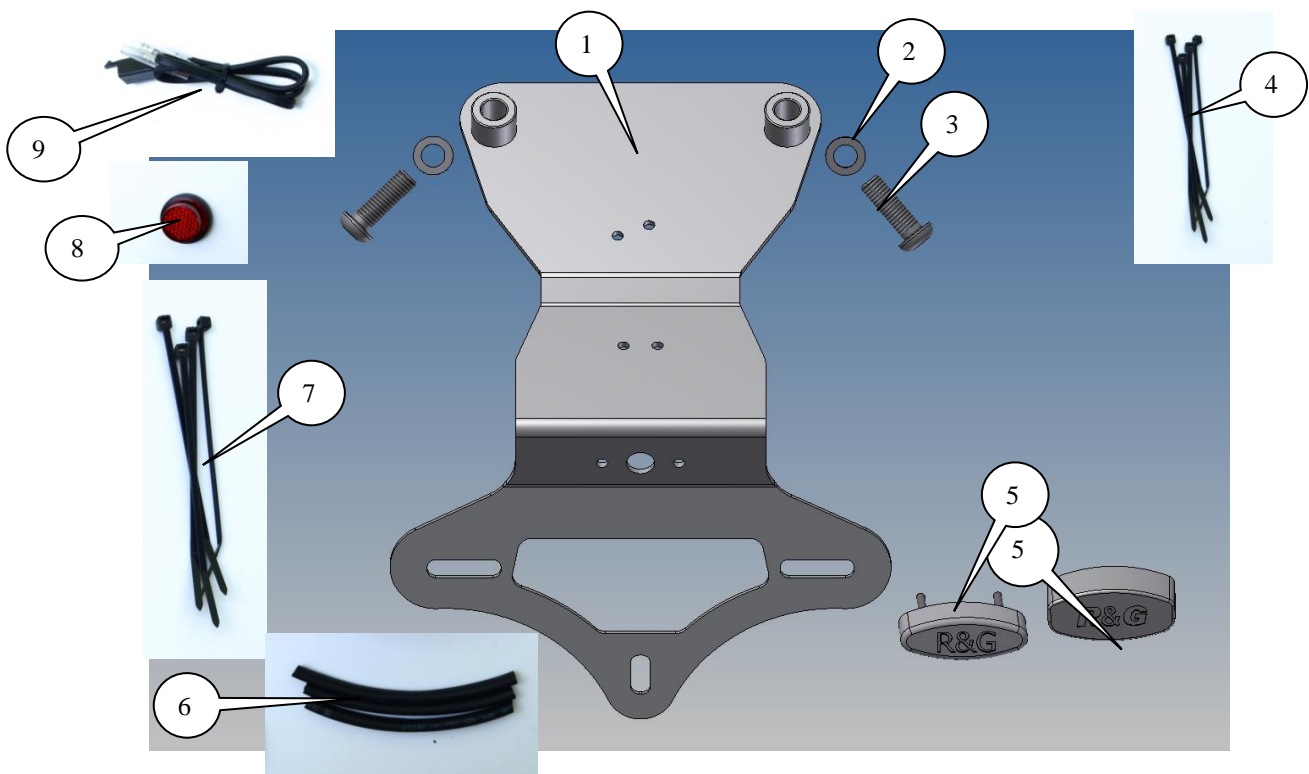

R&G Racing

Unit 1, Shelley's Lane, East Worldham, Alton, Hampshire, GU34 3AQ
Tel: +44 (0)1420 89007 Fax: +44 (0)1420 87301 www.rg-racing.com Email: info@rg-racing.com



LP0177

LEGENDE

- ARTICLE 1 = SUPPORT DE FIXATION DE PLAQUE (TB0177BK) (x1).
ARTICLE 2 = M8 RONDELLES (x2).
ARTICLE 3 = M8x25mm BOULONS (x2).
ARTICLE 4 = PETITS COLLIERS DE SERRAGE (x4).
ARTICLE 5 = ASSEMBLAGE FEU DE PLAQUE (LA0002) (x1).
ARTICLE 6 = 180mm LONGUEURS DE GAINÉ THERMO RETRACTABLE (x1).
ARTICLE 7 = COLLIERS DE SERRAGE (x3).
ARTICLE 8 = REFLECTEUR (REFL 1) (x1).
ARTICLE 9 = CONNECTEUR FEU DE PLAQUE (CON0014) (x1).
ARTICLE 10 = CLIPS AUTOCOLLANTS (x2) (NON INDIQUE).
ARTICLE 11 = 100mm MOUSSE AUTOCOLLANTE (x1).

Page | 9

Notez que si les kits sont emballés avec des rondelles en caoutchouc servant à tenir les composants, *ces rondelles doivent être jetées !*

OUTILS REQUIS

- Clés Allen 3, 4 et 5mm.
- Clés Torx T10 et T20.
- Un peu de superglue.

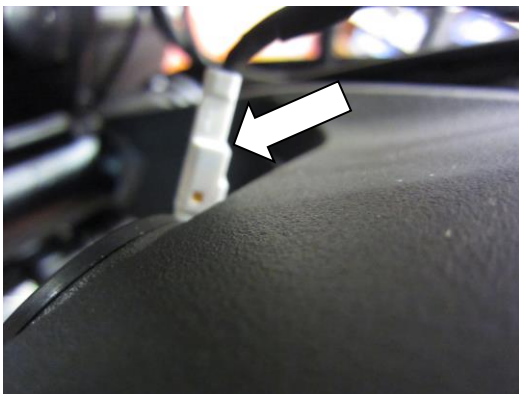

PHOTO 1

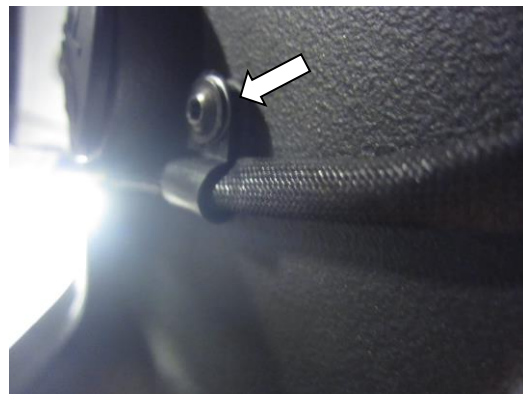

PHOTO 2

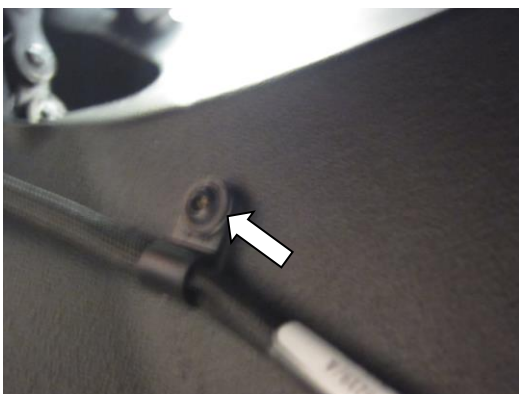

PHOTO 3

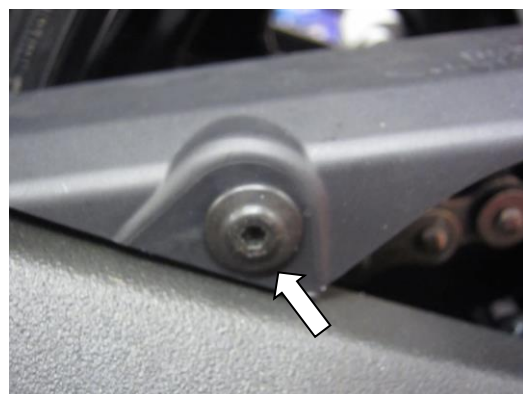

PHOTO 4

R&G Racing

Unit 1, Shelley's Lane, East Worldham, Alton, Hampshire, GU34 3AQ
Tel: +44 (0)1420 89007 Fax: +44 (0)1420 87301 www.rg-racing.com Email: info@rg-racing.com



LP0177

Page | 10



PHOTO 5

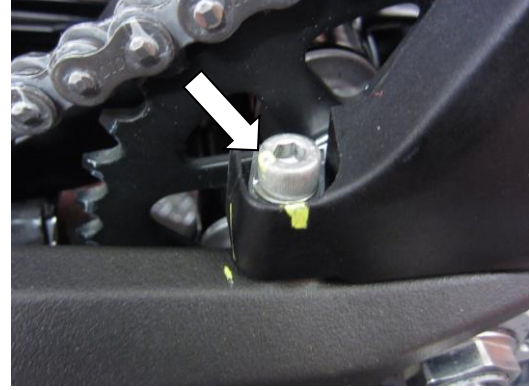

PHOTO 6



PHOTO 7

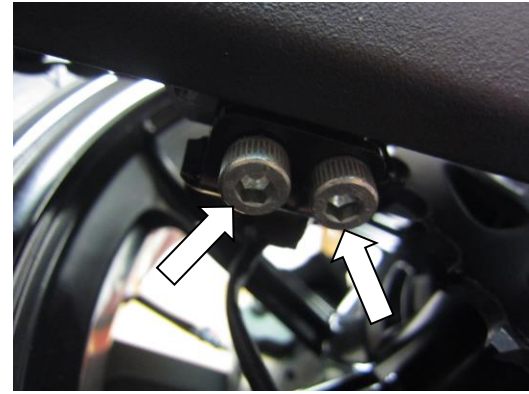

PHOTO 8



PHOTO 9



PHOTO 10



LP0177

Page | 11



PHOTO 11



PHOTO 12



PHOTO 13

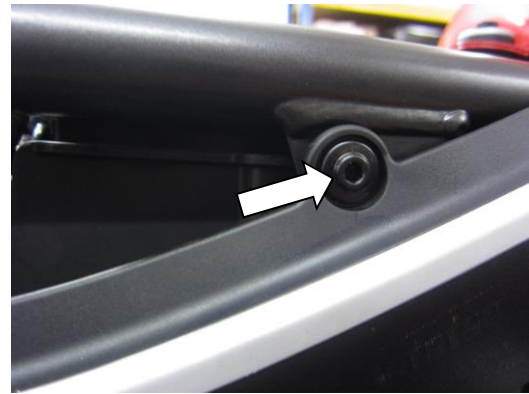

PHOTO 14



PHOTO 15



PHOTO 16



LP0177

Page | 12

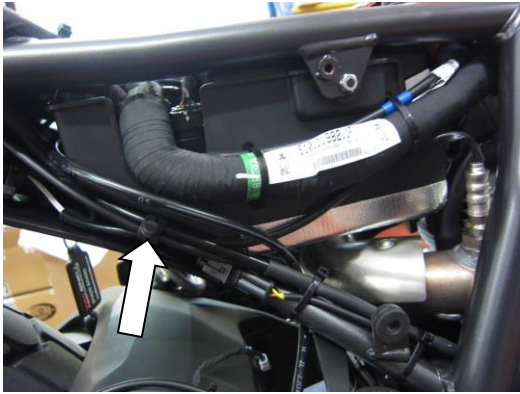

PHOTO 17

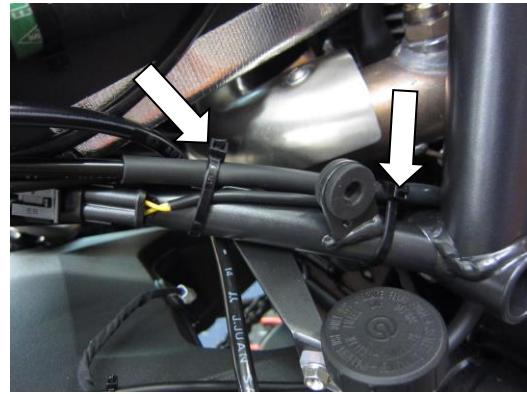

PHOTO 18

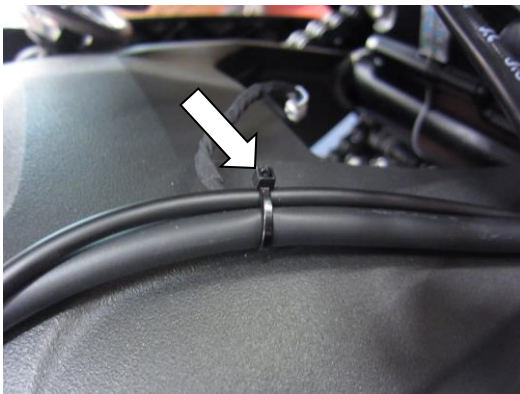

PHOTO 19

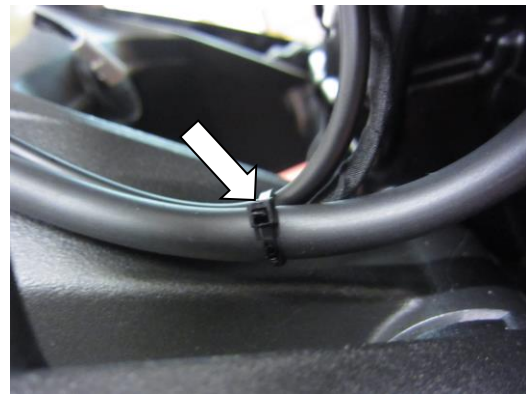

PHOTO 20



PHOTO 21



PHOTO 22



LP0177

Page | 13



PHOTO 23



PHOTO 24

INSTRUCTIONS DE MONTAGE

- Enlever le siège à l'aide de la clé.
- Déconnecter les prises de feu de plaque, voir photo 1.
- Tracer les fils au feu de plaque d'origine puis enlever toutes les agrafes de câble, voir photos 2 and 3.
- Enlever les 2 boulons, voir photos 4 et 5 puis enlever la protection chaîne (Seulement pour l'accès, et sera remplacé).
- Enlever les 4 boulons, voir photos 6, 7 et 8 et enlever le support de plaque. **Note:- Vous n'êtes pas obligé d'enlever le support entièrement si vous souhaitez le retenir et l'utiliser comme protection garde boue, dans ce cas vous n'avez qu'à enlever le support de plaque et le feu.**
- Monter le nouveau feu de plaque (article 5) sur le support de fixation de la plaque (article 1) voir photo 10 (Utiliser la gaine thermo rétractable fournie (article 6) pour protéger les fils).
- **NOTE : VOUS DEVREZ COLLER LE LINCEUL DE FU AU FEU LED DE LA PLAQUE A L'AIDE DE SUPERGLUE.**
- Utiliser les clips autocollants (Article 10) et 2 des petits colliers de serrage (article 4) au support puis fixer les fils, voir photo 11.
- Couper et tailler la mousse autocollante sur la surface supérieure du nouveau support de plaque, voir photo 12.
- Mettre le nouvel ensemble en place, voir photo 13 et fixer en utilisant les boulons M8 (article 3) et rondelles (article 2).
- Enlever les 4 boulons indiqués sur les photos 14, 15 et 16, puis enlever le panneau pour accéder aux fils.
- Enlever tous les colliers et fixations colliers indiqués sur les photos 17, 18, 19 et 20.
- Passez le feu de plaque dans le passage de roue / capot latéral, voir photos 21 et 22.
- Connecter le nouveau feu de plaque à la prise d'origine en utilisant le connecteur fourni (article 9) voir photos 23 et 24. Il est utile de mettre le contact à ce stade du montage, si cela échoue, inversez les fils puis revérifier le fonctionnement.
- Utiliser les colliers de serrage restants pour organiser les fils.
- Remettre le panneau latéral.
- Remettre la protection chaîne si requis.
- Monter la plaque sur le nouveau support de plaque. **NOTE : VOUS NE POUVEZ PAS UTILISER UNE GROSSE PLAQUE D'IMMATRICULATION AVEC CE PRODUIT.**

R&G Racing

Unit 1, Shelley's Lane, East Worldham, Alton, Hampshire, GU34 3AQ

Tel: +44 (0)1420 89007 Fax: +44 (0)1420 87301 www.rg-racing.com Email: info@rg-racing.com



LP0177

- **IMPORTANT: Si vous installez une grosse plaque, il y a un risque que la plaque entre en contact avec la roue arrière en cas de choc sur la route (bosse, grosse charge etc...). Il est de votre responsabilité de vérifier que cela ne puisse pas se produire. Ne pas effectuer ces vérifications peut entraîner des dommages ainsi que des blessures graves pour le pilote.**
- **Remettre le siège.**
- Depending on local laws, attach enclosed red reflector (article 8) in an appropriate location.
- Selon la loi locale, monter les réflecteurs (article 10) aux emplacements appropriés.
- Revérifiez que les clignotants, le feu arrière et le feu de plaque fonctionnent correctement avant de prendre la route.

Page | 14

Ces instructions de montage sont disponibles sur www.rg-racing.com

COUPLES DE SERRAGE

M4 BOULON = 8Nm
M5 BOULON = 12Nm
M6 BOULON = 15Nm
M8 BOULON = 20Nm
M10 BOULON = 40Nm

ISSUE 1 08/10/2014 (NSY)

CONSUMER NOTICE

The catalogue description and any exhibition of samples are only broad indications of the Products and R&G may make design changes which do not diminish their performance or visual appeal and supplying them in such state shall conform to the order. The Buyer acknowledges no representation or warranty (other than as to title) has been given or will apply to the Products other than those in R&G's order or confirmation and the Buyer confirms it has chosen the Products as being of merchantable quality and suitable for its particular purposes. Where R&G fits the Products or undertakes other services it shall exercise reasonable skill and care and rectify any fault free of charge unless the workmanship has been disturbed. The Buyer is responsible for ensuring that the warranty on the motorcycle is not affected by the fitting of the Products. On return of any defective Products R&G shall at its option either supply a replacement or refund the purchase money but shall not be liable if the Products have been modified or used or maintained otherwise than in accordance with R&G's or manufacturer's instructions and good engineering practice or if the defect arises from accident or neglect. Other than identified above and subject to R&G not limiting its liability for causing death and personal injury, it shall not be liable for indirect or consequential loss and otherwise its liability shall be limited to the amounts paid by the Buyer for the Products or the fitting or service concerned. These terms do not affect the Buyer's statutory rights.

R&G RACING RETURNS POLICY (NON-FAULTY GOODS)

Returns must be pre-authorized (if not pre-authorized the return will be rejected). Goods may only be returned direct to us if they were purchased direct from us (customer must prove if necessary). Otherwise to be returned to original vendor. Goods must be in re-sellable condition, in the opinion of R&G Racing. All returns are subject to a 25% restocking and handling fee (25% of the gross value exc. P&P – at the prevailing price at time of purchase). The customer must pay any and all carriage charges. No returns of discontinued products, unless within 14 days of purchase. This policy does not affect your statutory rights and does not refer to faulty goods.

R&G Racing

Unit 1, Shelley's Lane, East Worldham, Alton, Hampshire, GU34 3AQ

Tel: +44 (0)1420 89007 Fax: +44 (0)1420 87301 www.rg-racing.com Email: info@rg-racing.com