



CANsmart™ Controller

DNL.WHS.12300
Harley Davidson Series



DENALIElectronics.com/HD-CANsmart-User-Guide

Thank you for choosing DENALI

We know you would rather be riding your bike than wrenching on it, so we go the extra mile to make sure our instructions are clear and as easy to understand as possible. If you have any questions, comments, or suggestions don't hesitate to give our experts a call at 401.360.2550 or visit WWW.DENALIELECTRONICS.COM

Please Read Before Installing

DENALI products should always be installed by a qualified motorcycle technician. If you are unsure of your ability to properly install a product, please have the product installed by your local motorcycle dealer. DENALI takes no responsibility for damages caused by improper installation. **Caution:** When installing electronics it is extremely important to pay close attention to how wires are routed, especially when mounting products to the front fender, front fork, or fairing of your motorcycle. Always be sure to turn the handlebars fully left, fully right, and fully compress the suspension to ensure the wires will not bind and have enough slack for your motorcycle to operate properly.

Installation Tips

We strongly recommend using medium strength liquid thread locker on all screws and bolts. It is also important to ensure that all hardware is tightened to the proper torque specifications as listed in your owner's manual. For included accessory hardware please refer to the default torque specifications provided below. Inspect all hardware after the first 30 miles to ensure that proper torque specifications are maintained.

Bolt Size	in-lbs	ft-lbs	Nm
M3	10.0 in-lbs	-	1.0 Nm
M4	23.0 in-lbs	-	2.5 Nm
M5	44.5 in-lbs	3.5 ft-lbs	5.0 Nm
M6	78.0 in-lbs	6.5 ft-lbs	9.0 Nm
M8	-	13.5 ft-lbs	18.0 Nm
M10	-	30.0 ft-lbs	41.0 Nm
M12	-	52.0 ft-lbs	71.0 Nm

Hardware Sizing Guide

Not sure what size bolt you have? Use this ruler to measure screws, bolts, spacers, etc. Remember, the length of a screw or bolt is measured from the start of the "mounting surface" to the end of the screw, so only include the screw head when measuring countersunk screws.

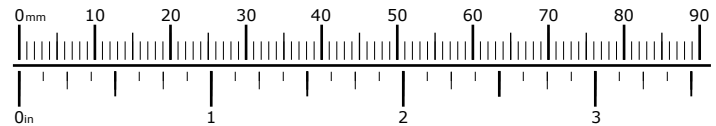

What's In The Box?



Kit Contents

- (a) CANsmart™ Controller.....Qty 1
- (b) 5ft Horn Extension.....Qty 1
- (c) 5ft LED Light Extension.....Qty 2
- (d) Brake Light Pigtail.....Qty 1
- (e) Passing Lamp Wiring Adapter.....Qty 2
- (f) Zip Tie.....Qty 4
- (g) Adhesive Dual Lock.....Qty 1
- (h) USB to Micro USB Programming Cable.....Qty 1

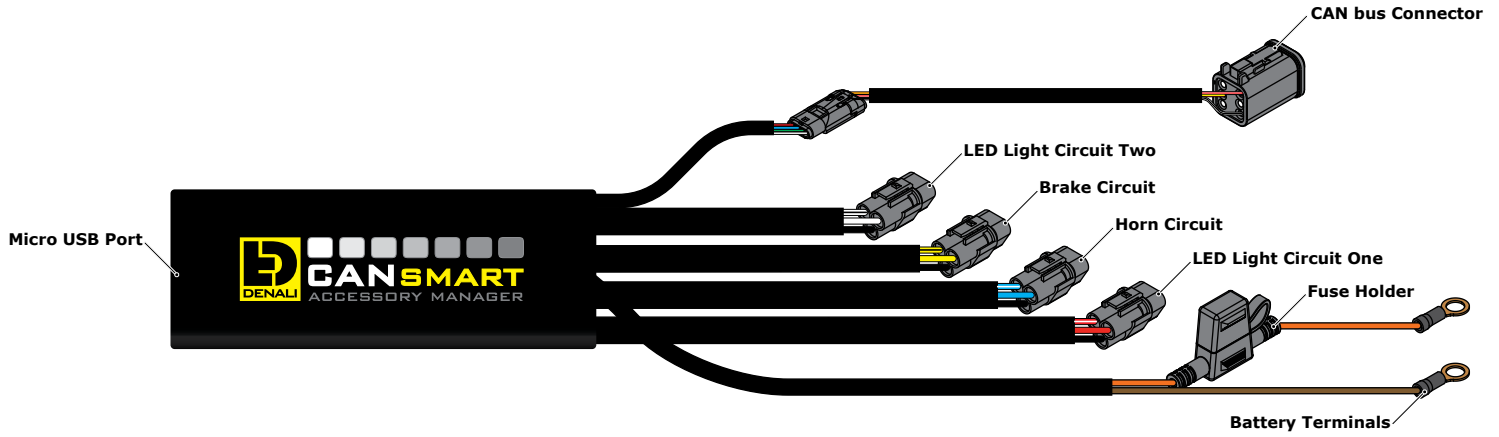

1.1 - Overview of Controller

The DENALI CANsmart™ Controller provides plug-n-play installation and integrated control of up to four accessories to enable dozens of customizable settings that can be controlled right from the vehicle's original controls or the CANsmart™ Accessory Manager Software.

The four circuits are pre-programmed to connect and independently control two sets of DENALI 2.0 lights, a SoundBomb horn, and our B6 auxiliary brake light. However, our Circuit Function Selector in the CANsmart software will let you run any accessory of your choice on any of the four circuits.

The illustration above depicts the preprogrammed default configuration, to see all available circuit functions and settings please refer *Section 5* or visit our online user guide at: DENALIElectronics.com/HD-CANsmart-User-Guide

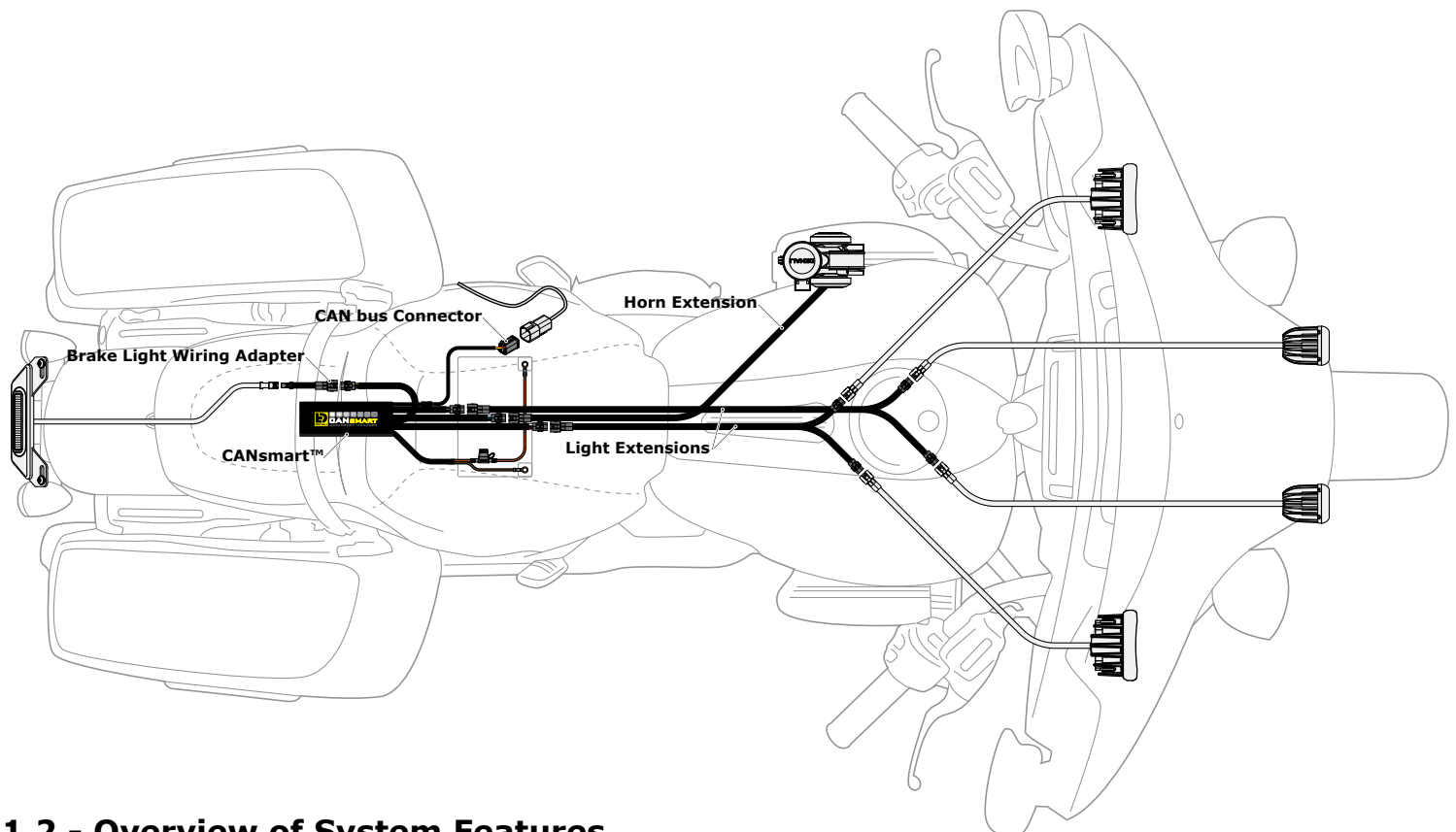

1.2 - Overview of System Features

The two auxiliary light circuits enable independent adjustment of high and low beam brightness right from the vehicle's trip switch. It also features a "flash to pass" and "strobe when horn active" setting that will strobe the auxiliary lights when you pulse your high beam switch or sound your horn.

The feature-rich brake light circuit will transform a simple 2-wire brake light into a "smart brake light" complete with running light, multiple flash patterns, and deceleration activated braking functionality.

The horn circuit enables the addition of an auxiliary horn without having to add a relay and dedicated horn wiring harness.

For a full list of features and available settings refer to *Section 5*.

2. Connecting To CAN bus & Battery

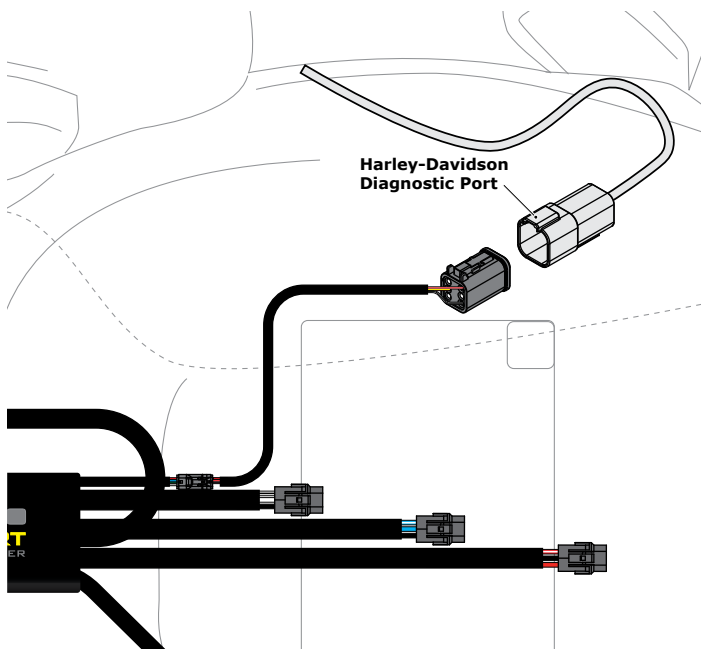

2.1 - Connecting To The CAN bus

Step One: Locate your bikes Diagnostic Port. The port is a gray 6-pin male Deutsch connector with a black rubber cap. In general the Touring, Dyna and Sportster models have the port located behind the left side cover, while Softail models locate the port underneath the riders seat. For the exact location, check your bikes owners manual.

Step Two: Remove the black cap from the Diagnostic Port

Step Three: Next plug the female 6-pin CAN bus connector on the CANsmart™ Controller into the Diagnostic Port.

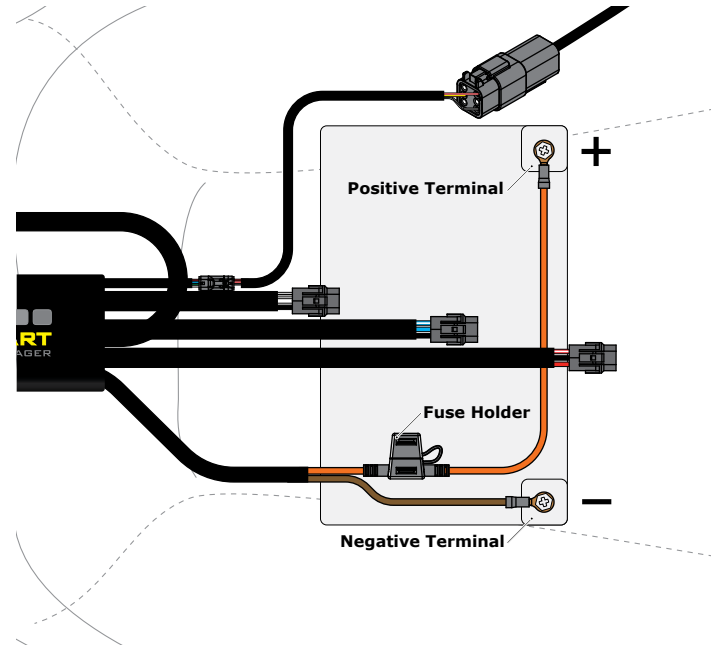

2.2 - Connecting To The Battery

Step One: Remove the fuse from the fuse holder.

Step Two: Gain access to the vehicle's battery and disconnect the negative (-) and positive (+) terminals.

Step Three: Connect the CANsmart™ wiring harness to the battery via the ring terminals. Be sure the orange wire lead with the fuse holder goes to the positive (+) terminal of the battery.

Step Four: Re-install the fuse into the fuse holder.

Note: Place the fuse holder in an easily accessible location for convenient service in the event of a blown fuse.

3. Connecting Accessories

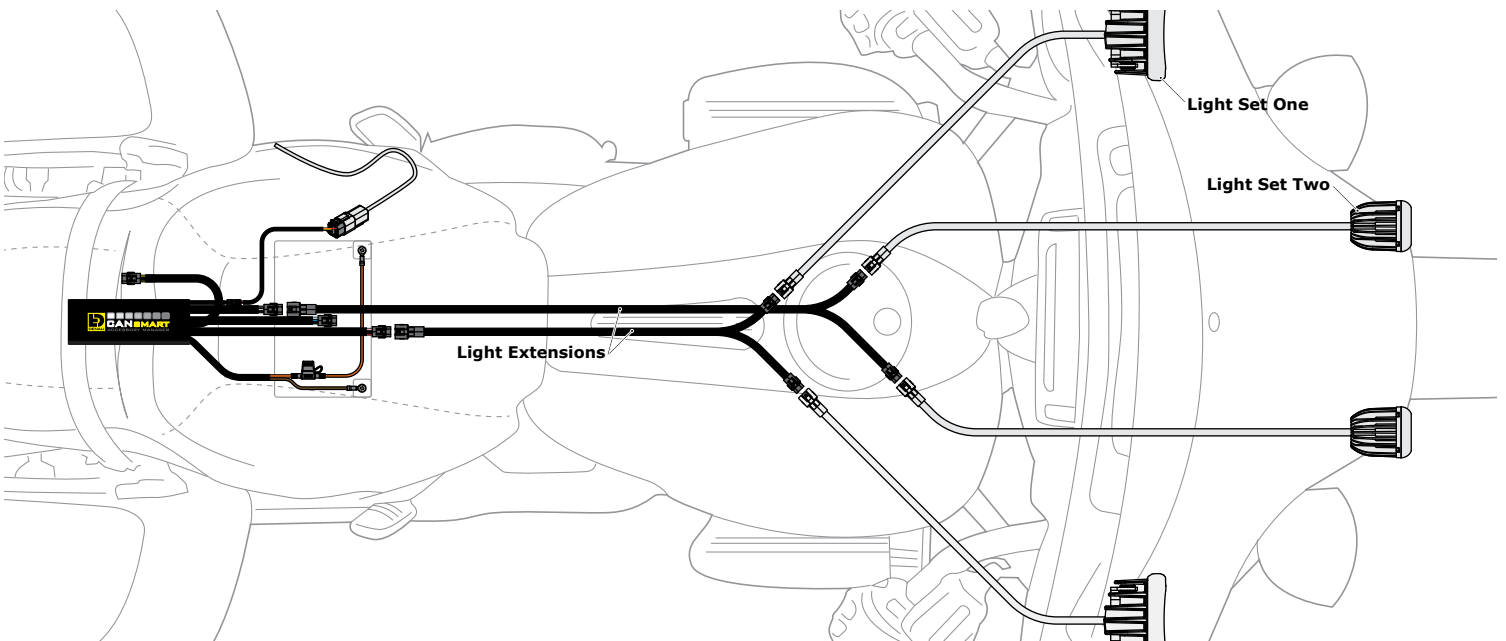

3.1 - Light Set One & Two - (Red & White Circuits)

In the default configuration, the circuit for Light Set One is the longest red lead, the shortest white lead is for Light Set Two. Both circuits are designed to handle up to 10 amps each.

Step One: Plug the male 3-pin connector of the Light Extension-Splitter into one of the CANsmart™ Controller's light circuits.

Step Two: Begin routing the harness toward the front of the bike. Secure the harness to the vehicle's frame along the way with the included zip ties. Be sure to avoid any moving components such as radiator fan blades or suspension.

Step Three: Plug the DENALI Light Pods into the female 3-pin connectors of the Extension-Splitter. Repeat steps *One* through *Three* using a second Light Extension-Splitter for the second set of lights.

Two-Wire Dimming: Turn off "Three-Wire Dimming Mode" for correct dimming operation of auxiliary LED lights that have only two wires. If enabled the 3rd yellow wire will be deactivated and PWM data will instead be transmitted through the red wire.

Wire two wire lights using the red wire for positive (+) and the black wire for negative (-).

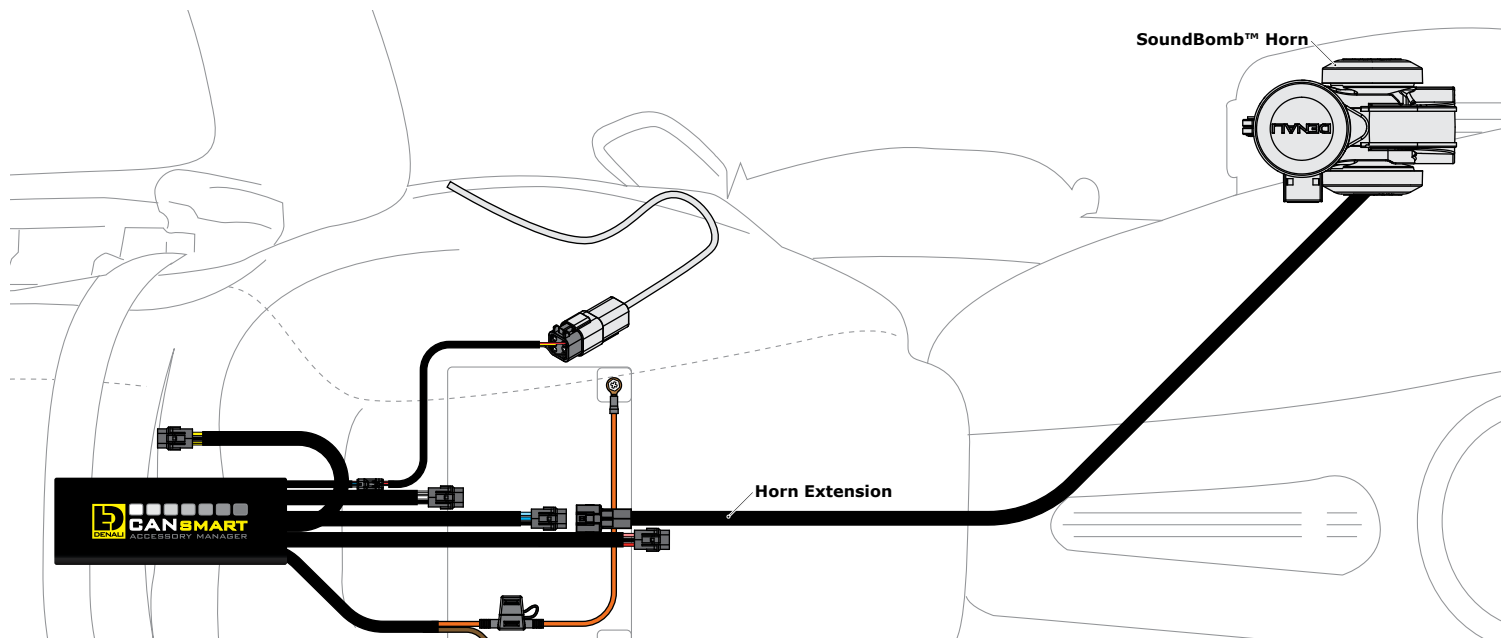

3.2 - Horn - (Blue Circuit)

Step One: Plug the male 2-pin connector of the Horn Extension into blue horn circuit on the CANsmart™ Controller.

Step Two: Begin routing the harness toward the front of the bike. Secure the harness to the vehicle's frame along the way with the included zip ties. Be sure to avoid any moving components such as radiator fan blades or suspension.

Step Three: Plug the spade connectors of the Horn Extension into the DENALI SoundBomb Horn. The Green wire connects to the positive (+) terminal on the horn, the Black wire goes to the negative (-) terminal.

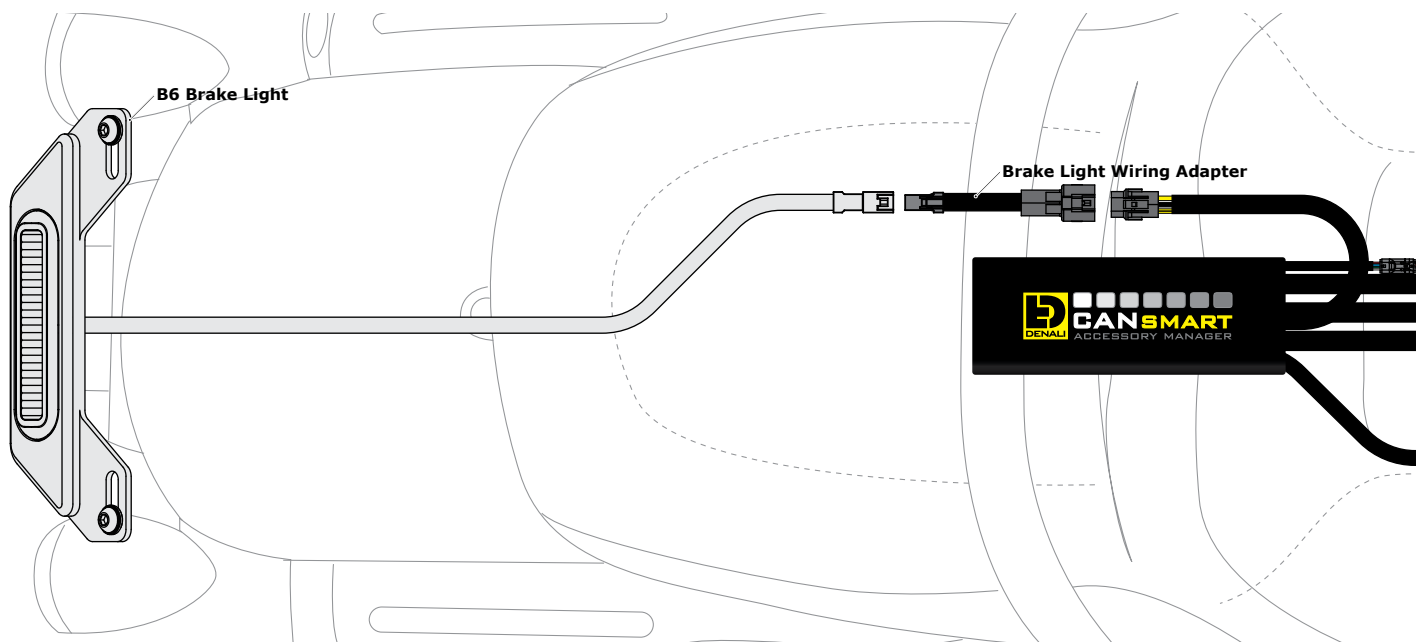

3.3 - Brake Light - (Yellow Circuit)

Step One: Route the harness of the DENALI B6 Brake Light from the rear of your motorcycle toward the CANsmart™ Controller.

Step Two: Plug the Brake Light Pigtail into the connector on the DENALI B6 Brake Light.

Step Three: Plug the male 2-pin connector of the Brake Light Pigtail into the yellow brake light circuit on the CANsmart™ Controller.

4. Alternate Light Wiring Options

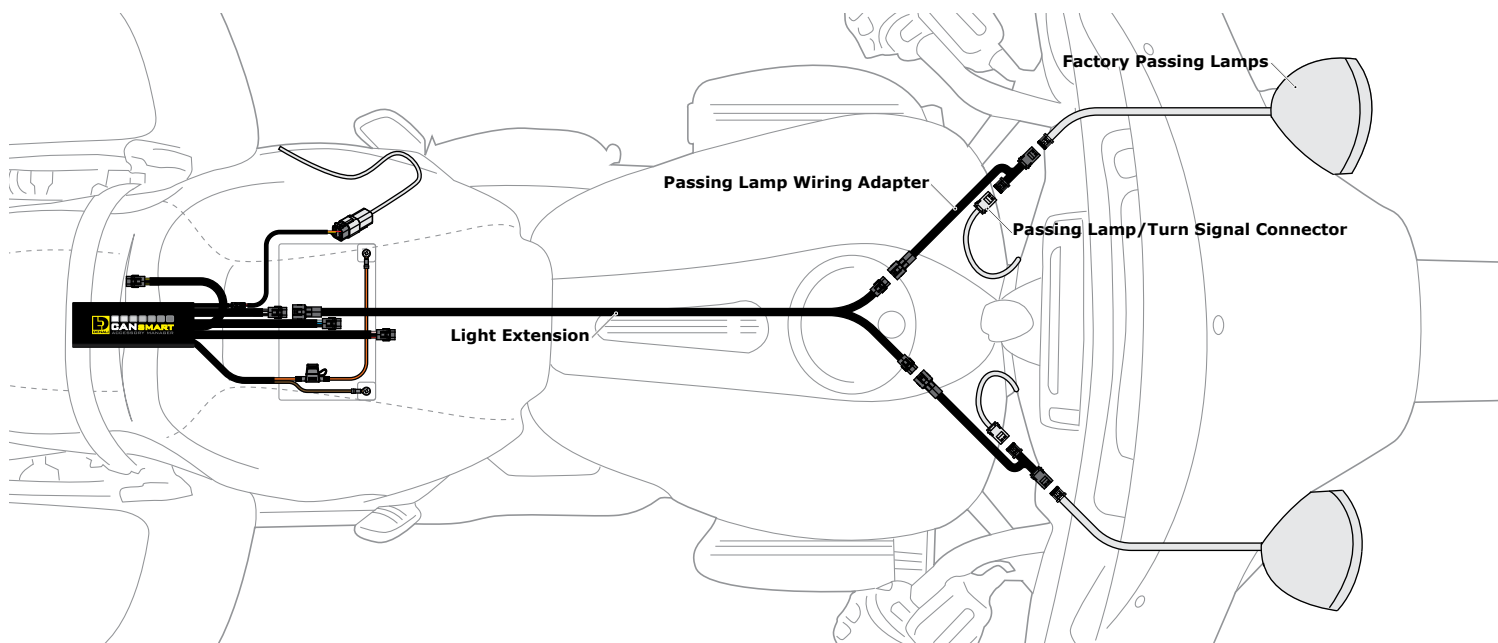

4.1 - Controlling Your Factory Passing Lamps

Step One: Plug the male 3-pin connector of the Light Extension-Splitter into one of the CANsmart™ Controller's light circuits.

Step Two: Begin routing the harness toward the front of the bike. Secure the harness to the vehicle's frame along the way with the included zip ties. Be sure to avoid any moving components such as radiator fan blades or suspension.

Step Three: Plug the male 3-pin connector of the Passing Lamp Wiring Adapter into the female 3-pin connectors of the Extension-Splitter.

Step Four: Disconnect the Factory Passing lamps from the motorcycle at

the Passing Lamp/Turn Signal Connector coming from the bikes main harness.

Step Five: The remaining 4-pin connectors of the Passing Lamp Wiring Adapter plug inline between the Factory Passing Lamps and the Passing Lamp/Turn Signal Connectors.

Step Six: Connect the CANsmart to the Device Manager Software and turn OFF "Three-Wire Dimming Mode" for the circuit that the Passing Lamps have been wired to.

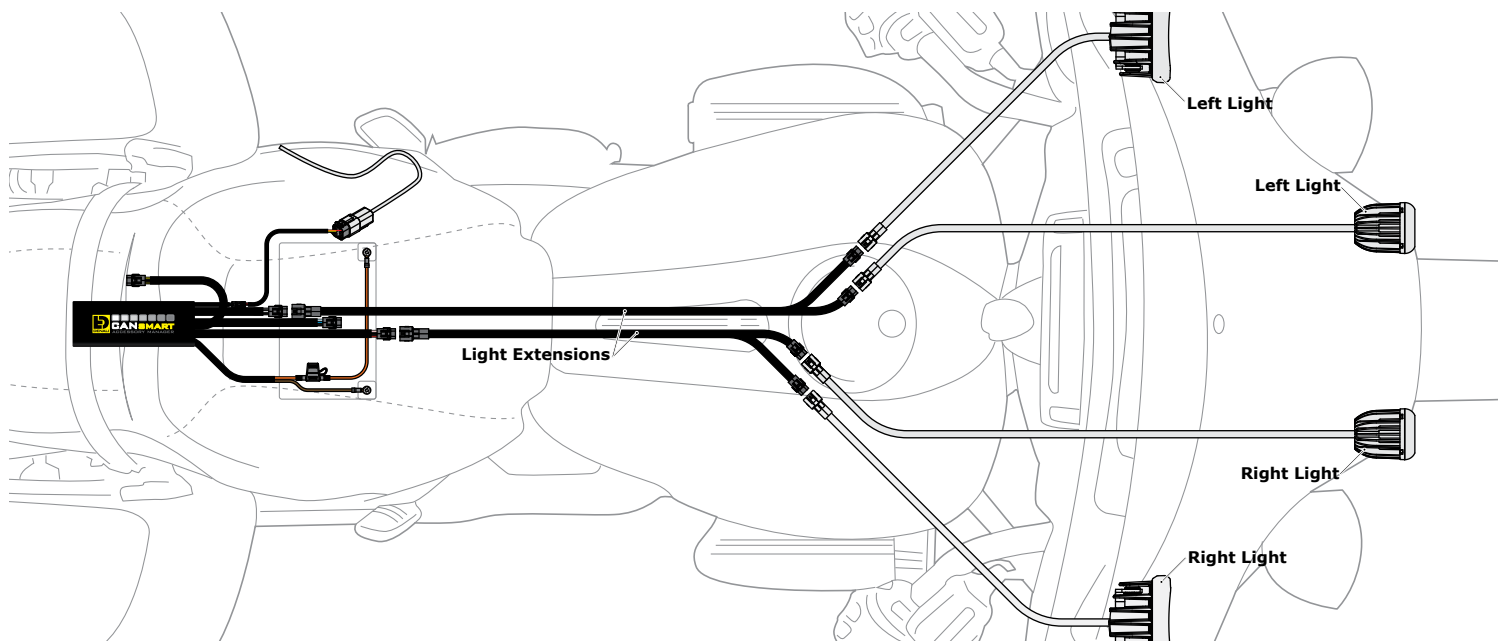

4.2 - Left/Right Split Lights

Wiring your LED Lights split left/right enables the "Off When Turn Signal Active" feature to cancel only the LED lights on the corresponding side of the bike that the signal was activated. When lights are wired as sets (Figure 3.1), the LED lights on both sides of the bike will cancel regardless which side turn signal is activated.

One: Plug the male 3-pin connector of the Light Extension-Splitter into one of the CANsmart™ Controller's light circuits.

Step Two: Begin routing the harness toward the front of the bike. Secure the harness to the vehicle's frame along the way with the included zip ties. Be sure to avoid any moving components such as radiator fan blades or

Step Three: Plug the DENALI Light Pods from the right side of the motorcycle into the female 3-pin connectors of the Extension-Splitter. Repeat steps One through Three using a second Light Extension-Splitter for the lights on the left side of the motorcycle

Step Four: Connect the CANsmart to the Device Manager Software. Using Circuit Function Selector, reassign the circuits used to be "Left Light 1" for the circuit powering the left side LED lights, and "Right Light 1" for the circuit powering the right side LED lights.

The screenshot shows the CANsmart Accessory Manager interface. At the top, it is powered by HEX INNOVATE. The main header reads "CANSMART ACCESSORY MANAGER". Below this, a section titled "Circuit Functions" instructs the user to "Click on the icons to change the function of each circuit".

Four circuit options are displayed at the top:

- Red Circuit:** LIGHT PAIR 1 (represented by a blue light icon)
- Blue Circuit:** HORN (represented by a green horn icon)
- Yellow Circuit:** BRAKE LIGHT (represented by a red exclamation mark icon)
- White Circuit:** LIGHT PAIR 2 (represented by a blue light icon)

Below these, a grid of 15 icons allows for selecting specific functions for each circuit:

- LEFT LIGHT 1, RIGHT LIGHT 1, LIGHT PAIR 1
- LEFT LIGHT 2, RIGHT LIGHT 2, LIGHT PAIR 2
- ACCESSORY (represented by a pink 'A' icon)
- HORN
- LEFT TURN, RIGHT TURN
- BRAKE LIGHT
- BRAKE & TURN LEFT
- BRAKE & TURN RIGHT

Technical specifications are listed below the grid:

- 10A continuous, 25A Maximum (for 25s) per circuit.
- 25A continuous current draw for the entire system

At the bottom of the interface are "Apply" and "Cancel" buttons.

6.1 - Circuit Function Selector

The Circuit Function Selector in the CANsmart software will let you run any accessory of your choice on any of the four circuits. Click on a circuit icon to open the drop down menu and make your selection from the list of available circuit functions. Continue reading for an overview of each circuit function and its available settings.

The screenshot shows the "Auxiliary Lights One" settings screen. The title "Auxiliary Lights One" is followed by a red dot and a three-dot menu icon.

Two light beam options are shown:

- HIGH BEAM:** Day Intensity is set to 100%, and Night Intensity is set to 100%.
- LOW BEAM:** Day Intensity is set to 50%, and Night Intensity is set to 50%.

On the right side, there are several toggle switches:

- Off when turn signal active
- Strobe when Horn active
- Strobe on "Flash to pass"
- Inverse flashing when hazards active
- Modulation

At the bottom right, there is a "Three-Wire Dimming Mode" toggle, which is currently turned on. Below it, a note reads: "Disable this mode for two-wire auxiliary LED lights".

6.2 - Auxiliary Lights One (Pair or Split)

The Auxiliary Light One circuit function enables independent adjustment of high and low beam brightness right from the vehicle's original switches. Available settings include "Off when turn signal active", "Flash when turn signal active", "Strobe when horn active", "Strobe on flash to pass", "Inverse flashing when hazards active" as well as "Modulation". "Three-Wire dimming mode" can be turned off to properly dim LED lights which do not have a dedicated 3rd dimming wire. From the extra settings window you can adjust the "Strobe Intensity" as well as the "Modulation variation".

Auxiliary Lights **Two**
○ ⋮



HIGH BEAM

Day Intensity 100 %

Night Intensity 100 %

Off when turn signal active

Strobe when Horn active

Strobe on "Flash to pass"

Inverse flashing when hazards active

Modulation

Three-Wire Dimming Mode
Disable this mode for two-wire auxiliary LED lights



LOW BEAM

Day Intensity 50 %

Night Intensity 50 %

6.3 - Auxiliary Lights Two (Pair or Split)

The Auxiliary Light Two circuit function enables independent adjustment of high and low beam brightness right from the vehicle's original switches. Available settings include "Off when turn signal active", "Flash when turn signal active", "Strobe when horn active", "Strobe on flash to pass", "Inverse flashing when hazards active" as well as "Modulation". "Three-Wire dimming mode" can be turned off to properly dim LED lights which do not have a dedicated 3rd dimming wire. From the extra settings window you can adjust the "Strobe Intensity" as well as the "Modulation variation".

Auxiliary Brake Light
● ⋮



BRAKE LIGHT

Running Light Intensity 10 %

Brake Light Intensity 100 %

Solid on braking

Brake Applied Flashing (Continuous)

Brake Applied Flashing (California legal)

Flash on Emergency Stop

Flash on Rapid Engine Braking

6.4 - Auxiliary Brake Light

The feature-rich Auxiliary Brake Light circuit function will transform a simple 2-wire brake light into a "smart brake light" complete with running light, multiple flash patterns, and deceleration activated braking functionality. From the extra settings window you can also adjust the "Brake Flashing Travel Speed" as well as the "Deceleration activated braking sensitivity".

Auxiliary Horn
● ⋮



HORN

Horn enabled

6.5 - Auxiliary Horn

The horn circuit enables the addition of an auxiliary horn without having to add a relay and dedicated horn wiring harness.

Accessory / Ignition Supply
● ⋮



ACCESSORY

Accessory Power

10 s Time-out

6.6 - Accessory

The Accessory circuit function will provide simple switched 12v power to an accessory of your choice when the motorcycles ignition is turned on.

Turn Signals

⋮





Running Light Intensity

0 %



Turn Signal Intensity

100 %

6.7 - Turn Signals

The turn signal circuit enables the addition of an auxiliary turn signals without having to tap into the bikes factory turn signal harness.

Run/Brake/Turn Light

⋮





Running Light Intensity

10 %



Brake Intensity

100 %



Turn Signal Intensity

100 %

Flash on Emergency Stop

Flash on Rapid Engine Braking

6.8 - Run/Brake/Turn

The run/brake/turn signal circuit enables the addition of an auxiliary run brake turn signals complete with flash patterns, all without having to tap into the bikes factory turn signal or brake harness.

6.9 - Where To Download The Software

The CANsmart™ Accessory Manager Software is available for both Windows and Mac operating systems. To download your copy please visit WWW.DENALIELECTRONICS.COM/BMW

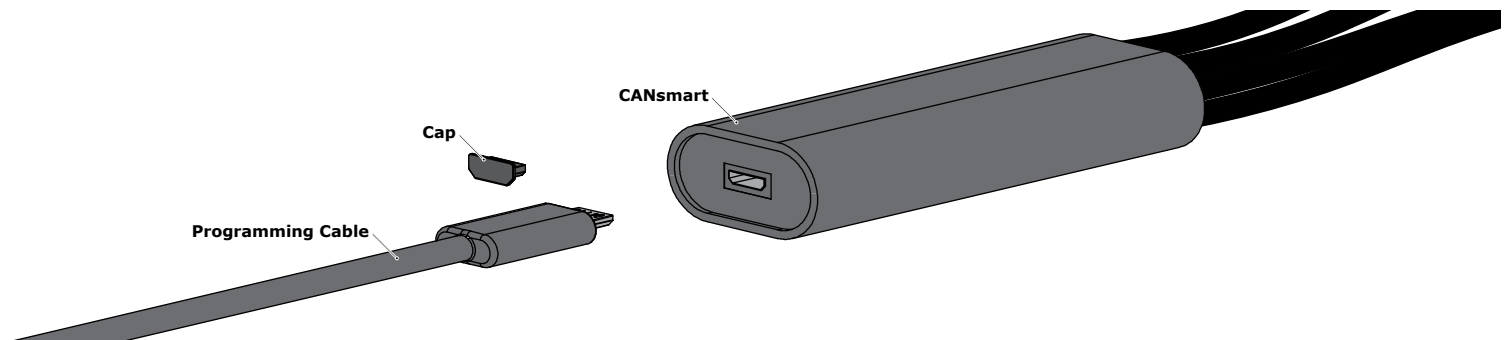

6.10 - Connecting The Device To The Software

- Step One:** Remove the protective cap from micro USB port on the end of the CANsmart™ Controller.
- Step Two:** Plug the provided programming cable into the CANsmart™ Controller, and plug the other end into your computers USB port.
- Step Three:** Open the CANsmart Accessory Manger Software and turn the motorcycle's ignition to the "ON" position.

7. Controlling Via The Motorcycle

Controlling Accessories From The Motorcycle

Auxiliary Lights One	
On/Off	Rapidly press "Trip" button 3 times.
Enter Dimming Mode	Hold "Trip" button for 1.4 seconds.
Adjust Intensity	When in dimming mode, press "Trip" button to adjust between 0% and 100%.
Exit Dimming Mode	Hold "Trip" button for 1.4 second or wait for 5 second time out.
Auxiliary Light Two	
On/Off	Rapidly press "Trip" button 3 times with the clutch lever pulled in.
Enter Dimming Mode	Hold "Trip" button for 1.4 seconds.
Adjust Intensity	When in dimming mode, press "Trip" button with the clutch lever pulled in to adjust between 0% and 100%.
Exit Mode	Hold "Trip" button for 1.4 second or wait for 5 second time out.
Auxiliary Horn (Green Circuit)	
Sound Auxiliary Horn	Press vehicle's original horn button.
Auxiliary Brake Light (Orange Circuit)	
Activate Auxiliary Brake Light	Apply vehicle's front or rear brakes. (Can be set to flash upon deceleration.)

Diagnostics
✕

Output Circuits

Red Circuit

Average: 0.00 A

Peak: 0.00 A

Blue Circuit

Average: 0.00 A

Peak: 0.00 A

Yellow Circuit

Average: 0.00 A

Peak: 0.00 A

White Circuit

Average: 0.00 A

Peak: 0.00 A

Output Circuit Test

Red Circuit

Blue Circuit

Yellow Circuit

White Circuit

Use the sliders to test circuits. Closing the diagnostics window will revert back to normal operation.

Horn and Accessory circuits can only be turned on at 100% intensity

System

Temperature

26.5 °C

Battery Voltage

0.00 V

Switch State

Open

Horn Input Voltage

0.00 V

CANBUS data

Inactive

Messages

Device not connected to battery. Please check connection and physical fuse.

No CAN bus data detected. This could be due to a faulty connection or ignition is off.

8.1 - Diagnostics Windows

The Diagnostics Window can be opened from the main menu. Use this window to get an overall view of the systems power consumption, as well as Battery/CAN bus voltage and device temperature.

Each circuit can be tested by sliding the slider underneath the circuit name. The unit must be connected to the battery or another source of 12V DC power in order to use the circuit test feature. The circuits will revert to normal operation when the diagnostics window is closed.

CANsmart™ Status Indicator Light Key

LED Color	Status	Solution
Solid Green	Normal operation, no errors present. (Vehicle Ignition ON)	N/A
Slow Flashing Green	Normal operation, no errors present. (Vehicle Ignition OFF)	N/A
Quick Flashing Green	Bootloader Mode (Should only be seen during firmware upgrade)	Connect to software, should reset into normal operation
Solid Red	Recovered from an unexpected failure	Connect to software, should attempt to reset to normal operation. Please report the exact circumstances to DENALI for analysis.
Flashing Red	At least one channels electronics fuse has been tripped.	Check/Increase fuse settings, cycle ignition to reset electronic fuses
Solid Green & Flashing Red	Application Firmware Corrupt	Connect to software, should offer an upgrade/recovery
Solid Red & Solid Green	Device has been deactivated	Return to DENALI for analysis. Please send log files info@DENALIElectronic.com for analysis by DENALI.
Flashing Red & Flashing Green	Data/configuration fault. (missing CAN bus data)	Check that the correct CAN bus connector was used. If the problem persists please send log files to info@DENALIElectronics.com for analysis by DENALI

8.2 - Status Indicator Light

The CANsmart controller features a LED status indicator light, the light is located next to the micro USB programming port. The chart above defines each of the LED colors/flash patterns, and provides possible solutions to any faults that are present in the system.

8.3 - Online Trouble Shooting Guide

For the most up to date comprehensive trouble shooting guide, please visit DENALIElectronics.com/BMW